



THE ROYAL MARINES

Badminton





Student Notes



Teacher Notes

Prepared for the Royal Navy in association with the Badminton Association of England Limited and produced by Education and Youth Limited, London.

If there is any support you feel the Royal Navy can give regarding this project please contact 0870 333 0423.

Acknowledgements

The Royal Navy wish to thank the Badminton Association of England Limited for their co-operation in this project.

Authors:

Barbara Jones Cert.Ed., Harry Jarvis M.Ed.

Technical Editor:

Phyl Edwards M.A.

CONTENTS

INTRODUCTION TO THE MODULE	3
SKILLS DEVELOPMENT SHEET	4
UNIT 1 INTRODUCTION TO THE PACK	5
UNIT 2 INTRODUCTION TO THE GAME	6
UNIT 3 DEVELOPING THE GAME	22
UNIT 4 ASSESSMENT OF BADMINTON	26
UNIT 5 THE FORMAL GAME	28
UNIT 6 PHYSICAL CONDITIONING	31
UNIT 7 MENTAL PREPARATION	34
UNIT 8 HEALTH AND FITNESS	35
UNIT 9 THE HISTORY AND THE STRUCTURE OF BADMINTON	36
UNIT 10 CURRENT ISSUES	38
UNIT 11 AWARD SCHEMES	39
UNIT 12 CODE OF CONDUCT	40
USEFUL ADDRESSES	41
RECOMMENDED READING	41





Message from the Badminton Association of England Limited

A major objective of the Badminton Association of England is:

“To promote and encourage the game of badminton; and to further the growth and development of the game of badminton.”

For this reason the Badminton Association of England welcomes this initiative of the Royal Navy in its efforts to encourage the further development of badminton in schools.

The purpose of this resource pack is to provide teachers with some basic ideas and practical methods which can be used to provide meaningful badminton experiences and knowledge for boys and girls following a GCSE or equivalent examination course. The pack includes information on a wide variety of badminton related topics, e.g. fitness, injuries, drugs. Additional information can be obtained from the Badminton Association of England and from the references at the back of this pack.

Introduction to the Module

Module Objectives:

Students will:

- be able to apply the techniques and skills of the game at a level commensurate with their ability;
- demonstrate an understanding of, and an ability to play and officiate the game of badminton;
- have an understanding of the structure of the sport at national and international level.

Method:

It is advocated that staff should adopt the problem solving approach to games teaching. To use this approach it is essential for staff to have an understanding of the game, and the game forms which relate to it. They must have a clear knowledge of the rule structure, and be able to modify existing playing areas to make the best use of the space available in which to teach the game.

Problem solving is an approach which develops the student's ability to make decisions by setting the scene or problem to which they must find the best response. Staff are encouraged to challenge students by setting tasks which are capable of a number of responses, by guiding the students to recognition of the most appropriate response, and by encouraging those responses with the greatest potential for success.

The problem solving approach is not an “easy option”, and requires a great deal of preparation in order to be able to create skill and game situations which are valid in terms of the sport, and which will assist the students to reach a successful outcome.

Lesson Planning:

In lesson planning the following should be taken into account:

Restrict skill sessions to a level where players can benefit, rather than be confused.

Work on fundamentals, e.g. control of shuttle, accuracy, consistency, speed, balance, principle of attack (i.e. increasing the chances of winning each rally).

Beware becoming “drill-drugged”; learning complicated drills takes time. Avoid isolation of skills where possible; they do not occur like this in the game.

Select practices appropriate to players' level of ability.

Offer alternatives when working in mixed ability groups.

Give recognition for achievement (may not be perfect, but the best standard students can achieve).

Technique first, then tactical awareness, BUT do not dilute technique work by looking for tactical and game understanding too early. They need the tools first.

The text and most illustrations refer to right handed players. This will require adaptation for left handed players for technique, group organisation and safety.

In each lesson, due emphasis should be given to co-operation as well as competition.





Skills Development Sheet

The beginning stage of learning Badminton is the exploratory phase, where the player is attempting to learn the correct sequence of movements of all the basic skills e.g. serve, return of serve, overhead shot. A number of errors may be made and players will need feedback to recognise and correct these errors. Initially a player may find it difficult to rally and have limited stroke range.

During the intermediate stage a player will be performing more consistently and with more quality e.g. good length. Timing and anticipation will improve although skills may break down under pressure in a game situation.

At the advanced stage all the basic skills are performed with quality and flair. Players are able to concentrate on more detailed aspects of the skills and the tactics required, producing surprise elements if needed.

Name of Module	Badminton
Basic Skills	High serve, low serve, full serve. Receiving service. Overhead strokes, forecourt strokes, defensive and counter attack strokes (page 13-21).
Game-play Skills	Maintaining balanced position to play shots; producing a good quality and variety of shots; fitness and ability to remain calm (page 22).
Tactical Skills	Play to strengths and opponents' weaknesses; maintaining consistency, accuracy, variety and deception; playing shuttle low on the other side of net; developing aggressive approach; getting the shuttle early (page 24)
Training Skills	Balance, flexibility, power, agility, speed, stamina, anaerobic power, muscular endurance (page 31-33); mental attitude (page 35).
Rules	See 'Laws of Badminton' by the Badminton Association of England (BAE). Address (page 41).





UNIT 1

Introduction to the Pack

This resource pack is provided to assist teachers in the organisation of a programme of badminton relating to the teaching and assessment of the subject within GCSE physical education or equivalent.

The pack is for guidance only, and further resources are recommended. Additional information may be obtained from the governing body whose contact address is found at the end of the pack.

Introduction to the Sport

Badminton is played throughout the world from beginner to international level by boys, girls, men and women. It is played by able-bodied and disabled people. Provision is made for ethnic groups and for women-only groups. It can be a simple game for beginners or a dynamic game for top athletes.

Badminton Association of England (BAE) Objectives

The Governing Body of the sport is the Badminton Association of England; it has a clearly defined set of objectives by which it rules and manages the sport.

1. To act as the governing body for the sport and recreation of badminton in England, the Isle of Man and the Channel Islands. To promote and encourage the game, and to further its growth and development.
2. To contribute to national and international goodwill, friendship and understanding in co-operation with the IBF and other bodies.
3. To affiliate to the IBF and adopt its current laws of the game.
4. To make and enforce the by-laws, regulations and guidelines for the game.
5. To protect the interests of the game and to work for improved facilities.
6. To create and promote by publicity and education an informed and interested public opinion of the value and importance of the game.
7. To promote and organise international matches and tournaments, exhibitions and other events.
8. To select, train and administer competitors to represent the association.
9. To provide courses of instruction in badminton skills and techniques, and in the teaching of these skills.
10. To act as an information source on the game.





UNIT 2 Introduction to the Game

Prior to starting to plan a badminton module it is important that staff should KNOW all information necessary to ensure the safety and well-being of the students.

SAFETY

It is important that staff should check both local authority rules and BAE Safety Guidelines, details of which are included at the end of the pack.

Check simple points such as:

The Playing Environment –

Check the condition of the floor. Remove spare shuttles lying around.

Playing Equipment –

Check for nets with torn, enlarged holes. Ensure that students are wearing suitable footwear.

Lesson Organisation –

Ensure that the class warms up and cools down. Control group activity.

These are only simple points, but are the types of things which take little time to check, but a great deal of time to put right should problems arise.

THE GAME

The game of badminton may be divided into the components shown right.

Principles of the game: Badminton is not a “possession” game but a “problem sending and solving” game, played on a divided court.

Skills of the game: The player uses moving and hitting skills to send the shuttlecock over the net into the opponent’s court.

Tactics of the game: Areas of the court (see Figure 2.1), net height and choice of strokes become strategically important as players try to outmanoeuvre each other to win the game.

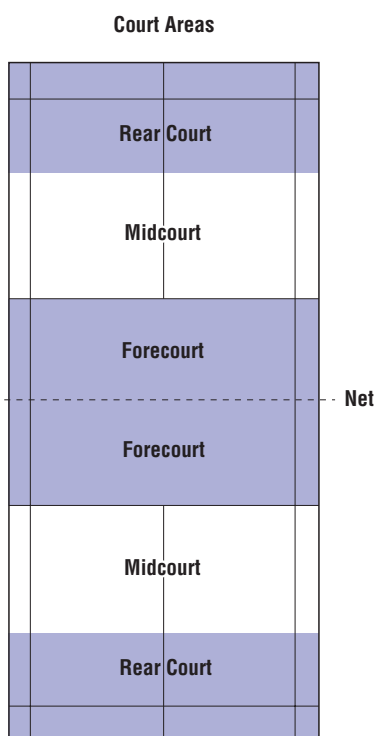
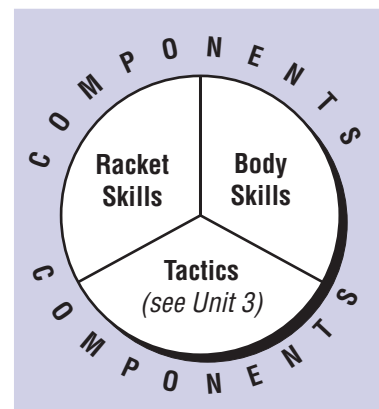

Figure 2.1

RACKET SKILLS

Getting Started

Co-operation Practices

Task 1

Aim

To keep the rally continuous.

Activity

In twos – maintain a rally with partner by hitting the shuttle over the net (see Figures 2.2 and 2.3).

As above but the players rotate at intervals on either a time or a number of hits basis, for example, when first pair achieves set target number.

N.B. If only one court is available, the layout in Figure 2.4 could be used.

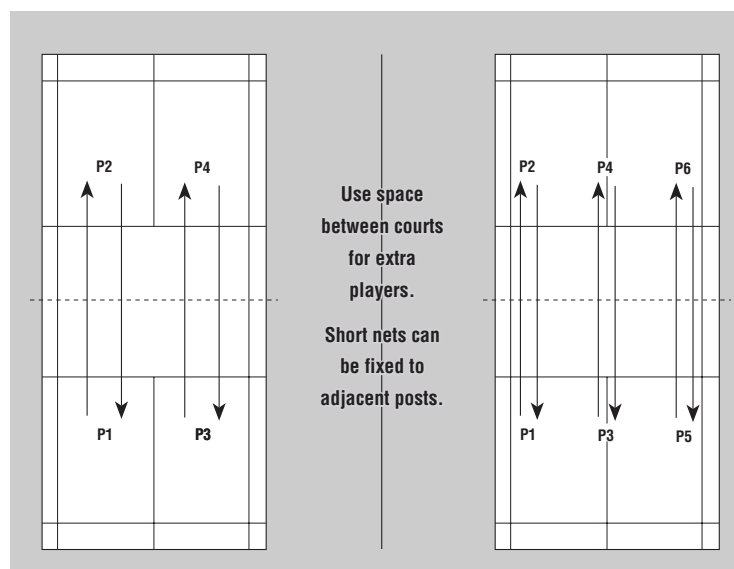

Figures 2.2 & 2.3





Figure 2.4

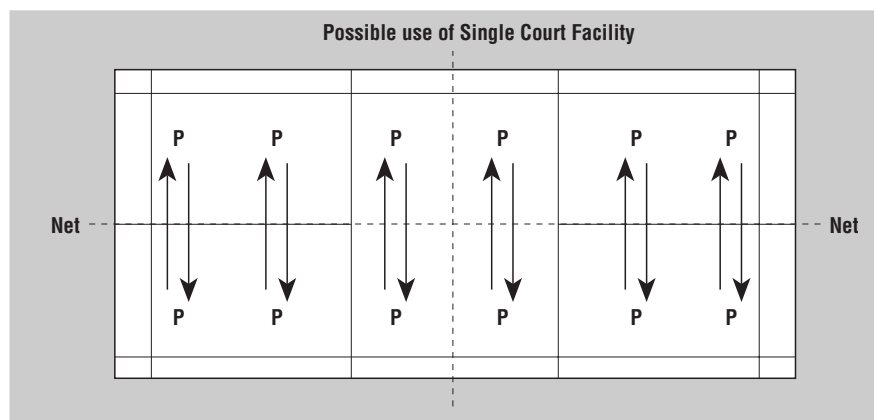

Observation Points

- Players return to the ready position between shots (racket in front of body, hand cocked, legs flexed and alert).
- Eyes track the shuttle and focus on contact.
- Racket contacts the shuttle in front of the body.

N.B. If there are more skilful players in the group use them as helpers.

Points to check

- Accuracy
- Consistency
- Co-ordination

Who checks?

- Teacher
- Self
- Other student*

* If using another student, (s)he could be off court and in a position to see the whole stroke; for example, when working in a group of three.

RACKET FACE CONTROL

In order to achieve this the grip is important. There are 4 basic grips (see Figure 2.5).

N.B. Always ensure that the racket handle is held mainly in the fingers as well as in the palm, and that the shuttle is hit with a flat racket face.

Task 2

Aim

To hit the shuttle over the net using the correct grip.

Activity

As Task 1, but players practise forehand and backhand separately before mixing at will, hitting the shuttle from and to different areas around the body, changing to the appropriate grip and trying to outmanoeuvre each other within defined court areas.

Staff Notes

For weaker students:

- Start by using a hand feed.
- Progress to a racket feed, one hit – stop – recover – repeat.
- Progress to a continuous racket feed.
- A short badminton racket may help students with co-ordination problems.

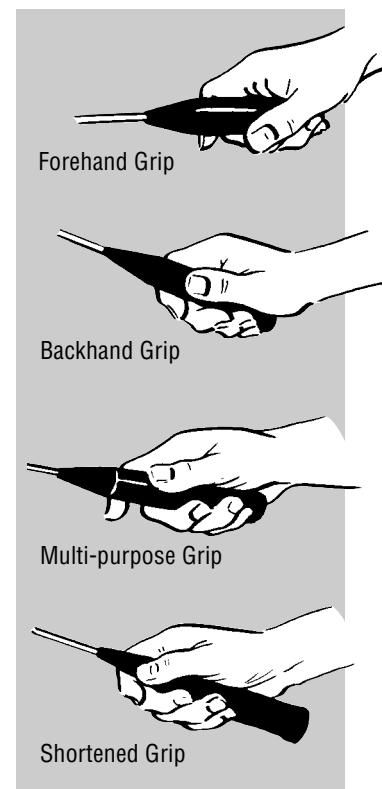

Figure 2.5





Guided Discussion Which part of the hand do you feel is guiding the racket face on forehand and backhand?

- Staff Notes*
- Palm of hand behind the handle on the forehand side.
 - Pad of thumb behind the handle on the backhand side.

RACKET HEAD CONTROL: HITTING ACTIONS

All strokes can be played with one of the hitting actions illustrated in Figure 2.6. Stroke development can be relatively easy if some time is spent in each lesson getting the “feel” of the actions.

Task 3

Aim To keep the shuttle going low over the net.

Activity Rally with a partner using the feeling of a push action.

- Observation Points*
- Guide the shuttle by pushing the racket head along the line of flight.
 - Step towards the shuttle on the racket foot. (N.B. right handed player right foot, left handed left foot.)

Development Players start in the midcourt position and then gradually reduce the length and change the angle of the push until the partner is brought from midcourt closer to the forecourt.

Task 4

Aim To make the shuttle travel fast between the players.

Activity Rally with partner using the feeling of a tap action. Hit from and to the midcourt areas.

- Observation Point*
- Check that the hand uncocks with a sharp tap along the line of flight, with a quick rebound recovery of the racket head to cock the hand again.

Development Try to make the shuttle skim the net.

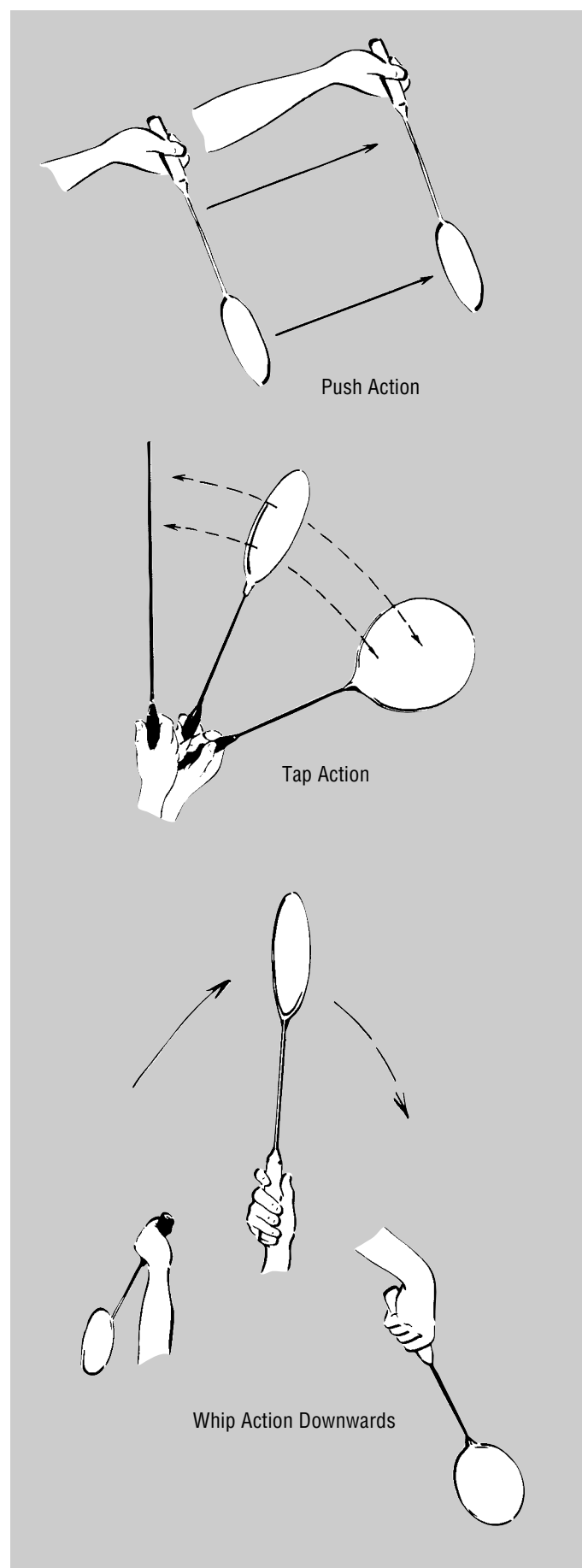

Figure 2.6





Task 5

- Aim** To hit upwards with force over the net, using the feeling of a whip action.
- Activity** In twos (see Figure 2.7) – Player 1 hand feeds low over the net to the forecourt. Player 2 uses an underarm whip action to send the shuttle towards the rear court. The feeder can run backwards to catch the shuttle.
- Development** For accurate placement, Player 2 tries to make the feeder move back to the tramlines to catch the shuttle.

Task 6

- Aim** To hit upwards or downwards over the net with force, using the 'whip' action.
- Activity** In threes (see Figure 2.8) – Hand feed to Player 1 who uses the feeling of an underarm whip action to send the shuttle up to Player 2 who uses the feeling of an overarm whip action to hit down over the net.
- Development** Player 1, having hit the shuttle upwards, moves back to midcourt and defends by pushing the shuttle low over the net to the feeder.
- Staff Notes**
- Check the quality of the feed in all practices.
 - Encourage players to use the self analysis approach, by getting them to focus on how well they are performing specific actions.
 - After co-operative experience, tasks may become competitive; scoring systems can be devised.
 - Give players the opportunity to use these skills in a game form by playing half-court singles.
 - Use the badminton scoring system which is similar to volleyball and squash, i.e. a point can only be won by the side serving. In half-court games the players do not have to be concerned about right and left hand courts.

BODY SKILLS

Body skills are as important as racket skills, and should be incorporated into every lesson. Figure 2.9 below shows an analysis of the basic body skills.

BODY SKILLS			
Ways of Moving (Travelling)	Common Skills	Directions of Movement	Quality of Movement
Walking	Posture	Forwards	Lightness
Running	Balance	Backwards	Control
Chasséing	Centre of gravity awareness	Sideways	Economy
Jumping		Diagonally	Speed
		Upwards	
		Downwards	
Special Skills		Function in Game	
Starting/Stopping		Integral part of stroke cycle	
Extended step (lunge)		First stage in reply	
Change of direction		Gets player to new position	
Jumping/Landing		Assists in action (example trunk turn)	
Crossover step		Aids recovery	
Rebounding			
Spin jumps			
Rear court backhand corner approach			
Scissor jump (switch feet in flight)			

Figure 2.9

Body skills can be included in many activities, but it is important always to pay attention to quality of movement.

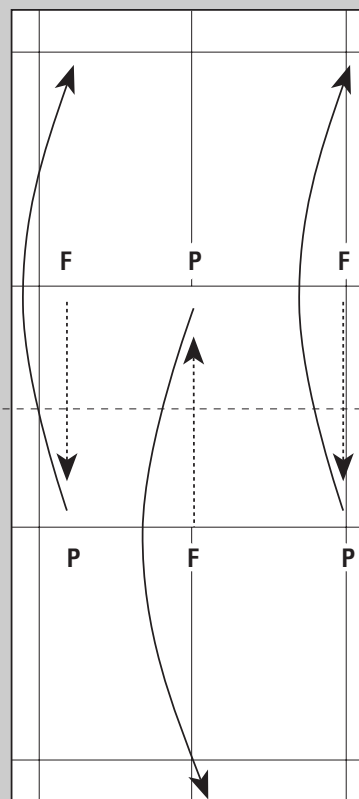

Figure 2.7

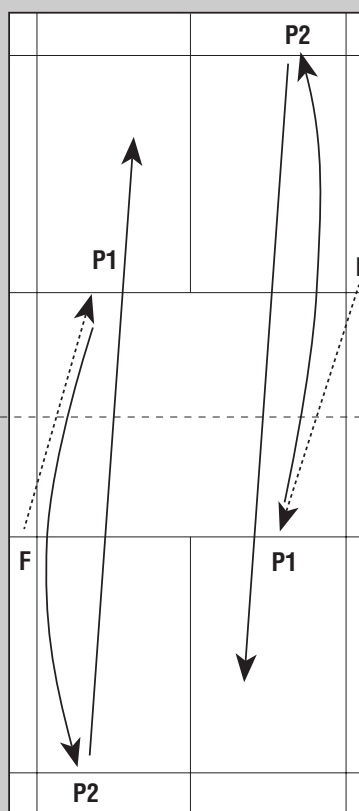

Figure 2.8





DEVELOPING THE QUALITY OF BODY SKILLS

Figure 2.10 below illustrates ways of developing body skills:

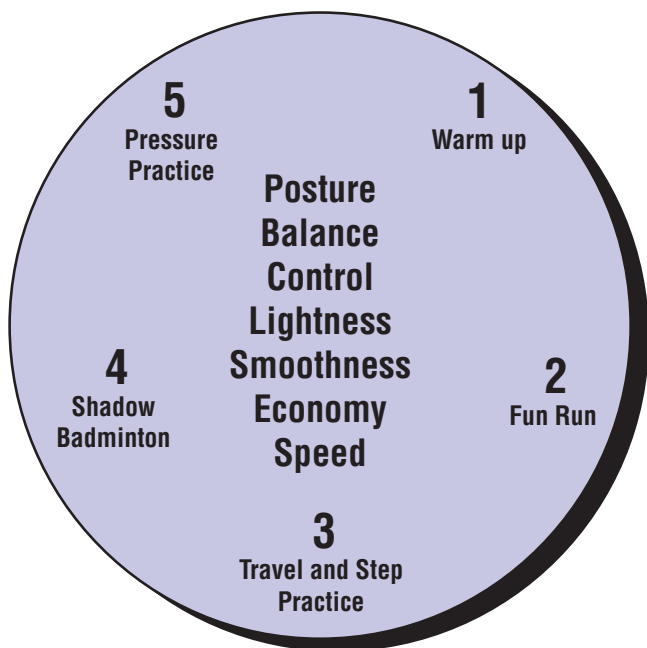

Figure 2.10

(1) Warm Up

The warm up should always be specific to the game or the activity which is to follow.

Experience different methods and directions of moving. Examples:

a) Chassé step

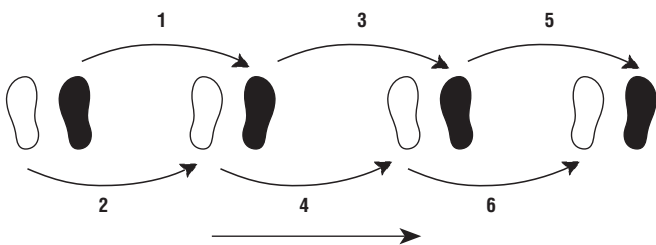

Figure 2.11

b) Crossover step

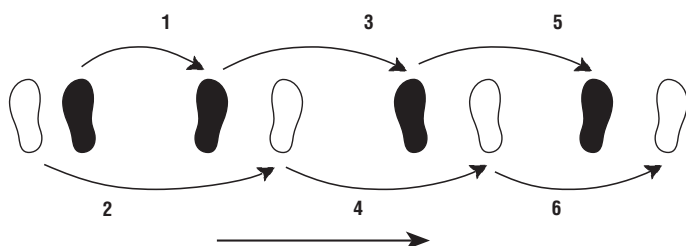

Figure 2.12

c) Split step

A small jump onto two feet at the same time.

Aim

- To load muscles ready to move in next direction, pushing from both feet.

Position of feet in split position will vary.

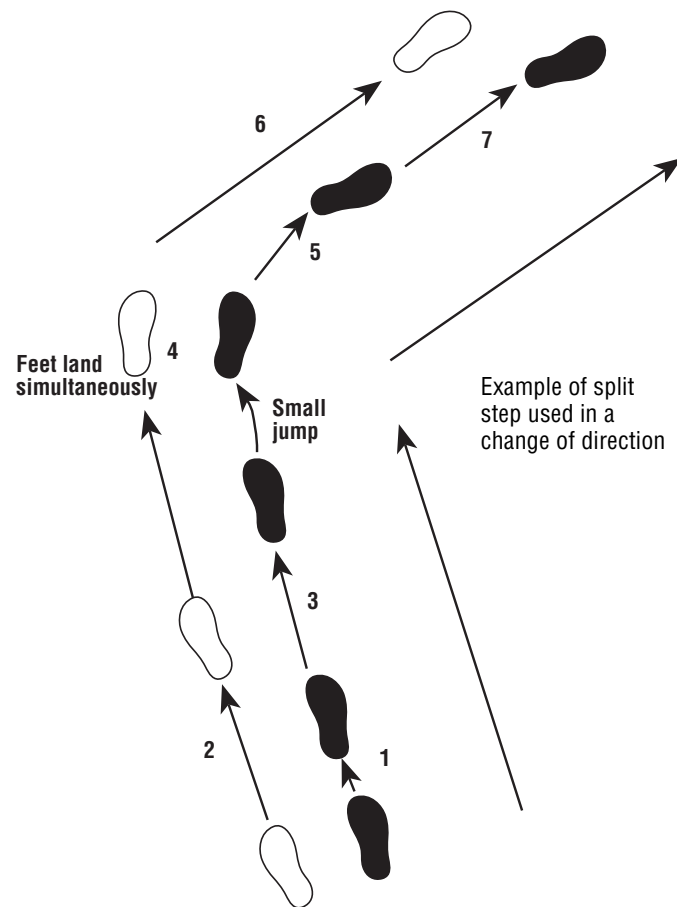

Figure 2.13

d) Running steps (forwards and backwards)

e) A combination of ways

(2) Fun Run (See Figure 2.14)

Move on the lines only. 2-6 players at one end of the court. Player 1 holding the shuttle is "it" and chases other players until able to touch one of them with the shuttle which is still held in the hand. The touched player is now "it".

Try different ways of moving, for example walking, running, chasséing, running and jumping or any combination of these.

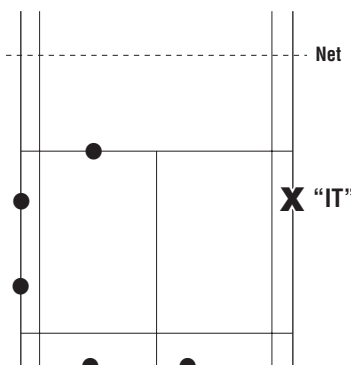

Figure 2.14

(3) Travel and Step

a) One step practices

Step onto racket foot and recover. Do this forwards, sideways, backwards to forehand and backhand side.





b) Travel and step practices

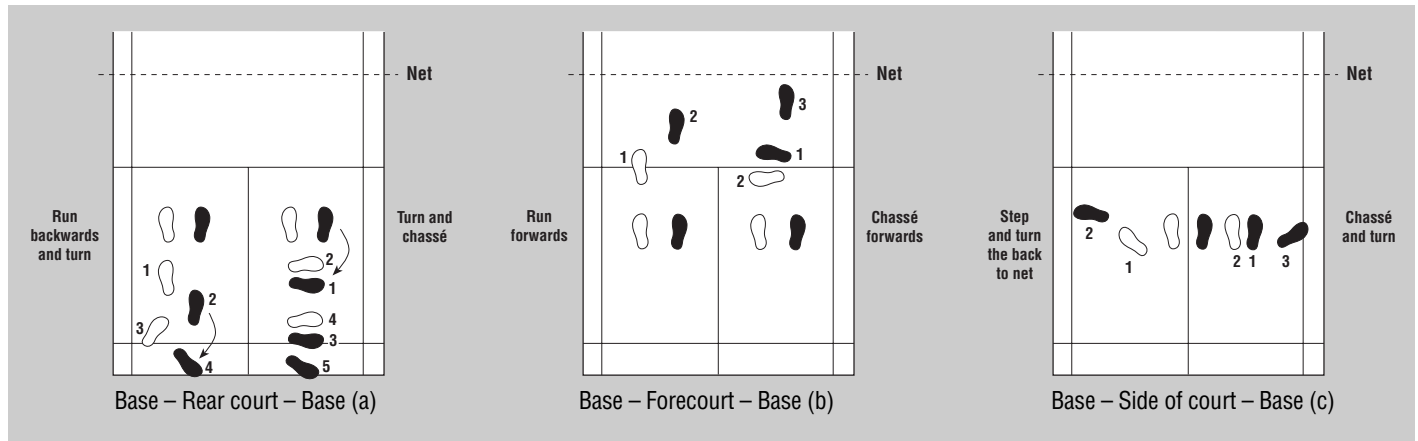

Figures 2.15 a/b/c

Staff Notes

- Use an extended last stride onto the racket foot – actual number of steps may vary according to individuals.

Staff Notes

- Keep the emphasis on technique, not fitness.
- Note the opportunities for use of flexed legs and both legs working together for power; 'load the muscles'.

(4) Shadow Badminton

Task 7: Play the World Champion

Aim To improve movement around the court.

Activity Use same area as in fun run, or half of it (see Figure 2.16). Player moves around the area "playing against the world champion", simulating strokes in all parts of the area. An alternative could be for players to face each other across the net, in opposite areas. One moves as above, the other "mirrors" the movement.

Figure 2.16

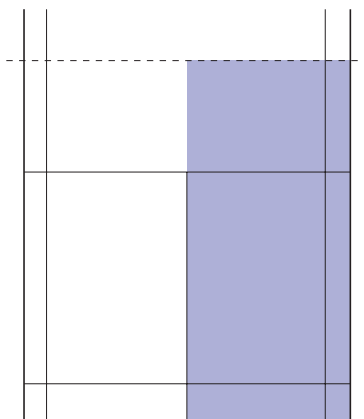

Developments

Experiment with ways of changing direction smoothly and quickly.

Combine ways of moving, e.g.
 run/lunge
 chassé/lunge
 chassé/jump
 run/jump.

Explore ways of starting quickly, stopping effectively, changing pace.

Observation Points

- Check posture and balance – head up, back straight, trunk vertical.
- Listen for lightness.

Guided Discussion

- What are the various ways of moving?
- What advantages do they have?
- What is meant by 'Quality' of movement?
- What methods of changing direction can be used?
- How can speed be increased?
- What are the effects of increased speed?
- How can you use your centre of gravity for control?

(5) Pressure Practices

When the player is under pressure is the time when skills may break down; keeping skills together under pressure will enhance performance.

Task 8

Activity

Hand feed shuttles to forecourt player who moves quickly to a balanced hitting position, plays specified stroke to target area, for example net kill into tramlines, and returns to base (see Figure 2.17). Feeding can be in a fixed order, then random. 6-12 shuttles, followed by a rest.

Figure 2.17

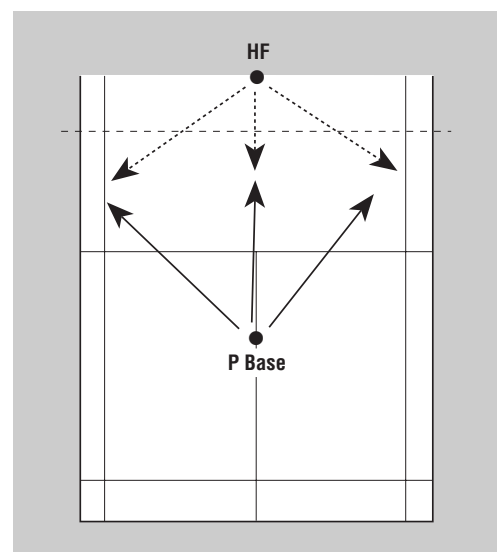



Task 9

Activity

Hand feed to sides, using two feeders (see Figure 2.18). This can be built up in stages: feed to forehand, feed to backhand, feed alternate sides, feed at random.

Player hits to nominated area, e.g. straight drive to rear court.

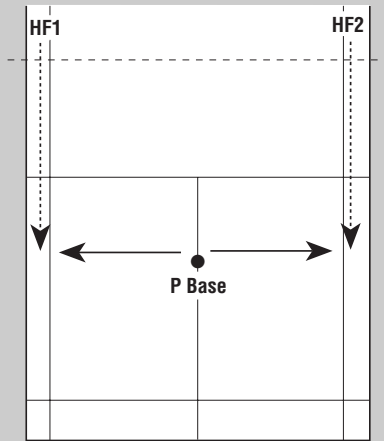

Figure 2.18 Key: HF = hand feed P = player

Staff Notes

- Lay emphasis on footwork.
- Practise footwork in isolation before adding a stroke.
- Constantly check the quality of the feed, which is a skill in itself and may need practice.

THE STROKE CYCLE

All strokes are made up of the following cycle:

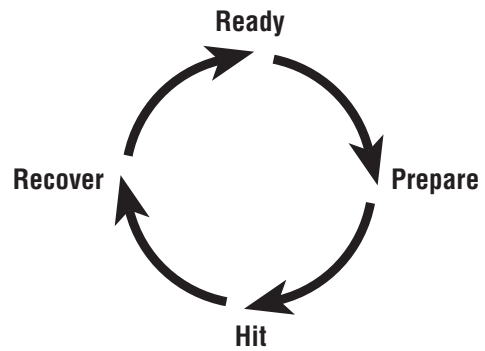

Figure 2.20 below illustrates the full range of strokes.

N.B. Ensure feeders cannot be hit in the face by a returning shuttle.

Task 10

Activity

Use racket feeder for longer hit from the rear court; let the player recover to base before feeding next shuttle (see Figure 2.19). Player hits to specified targets, e.g. smash to mid court.

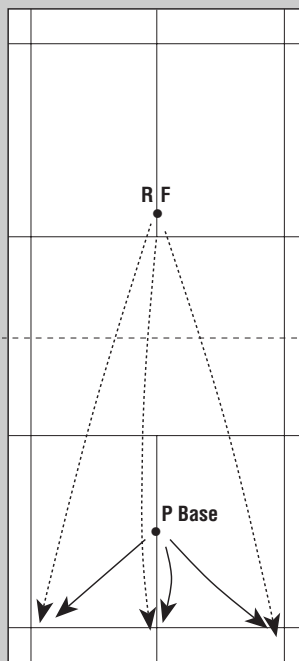

Figure 2.19 Key: P = player RF = racket feed

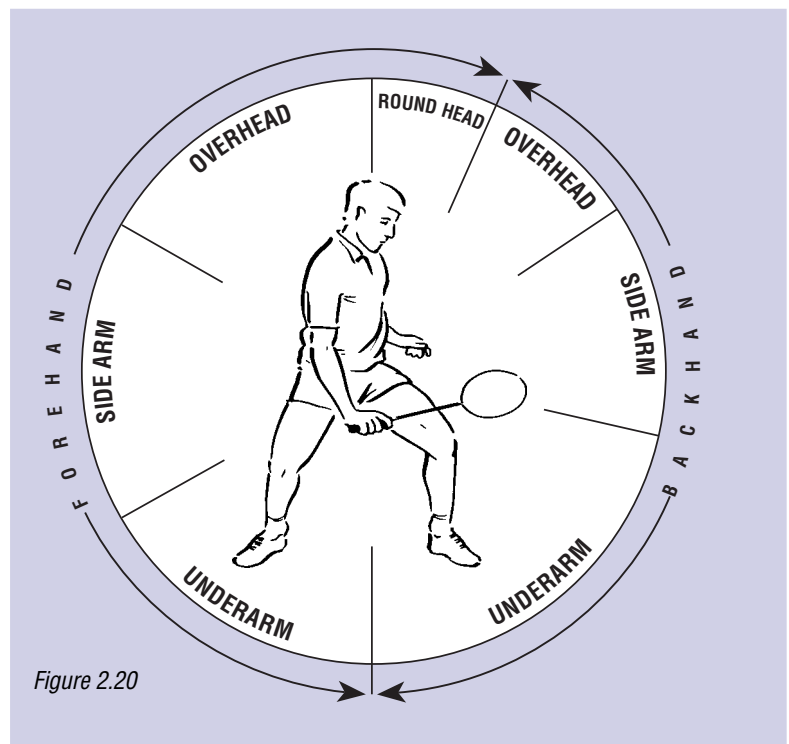

Figure 2.20





THE STROKES AS MOVES IN THE GAME

In this section emphasis is put on the use of strokes as opening moves (serve/return of serve) and as subsequent moves in the game.

Stroke: The High Serve (Singles)

Description See Figure 2.21.

Aim To make the opponent move as far back in the court as possible.

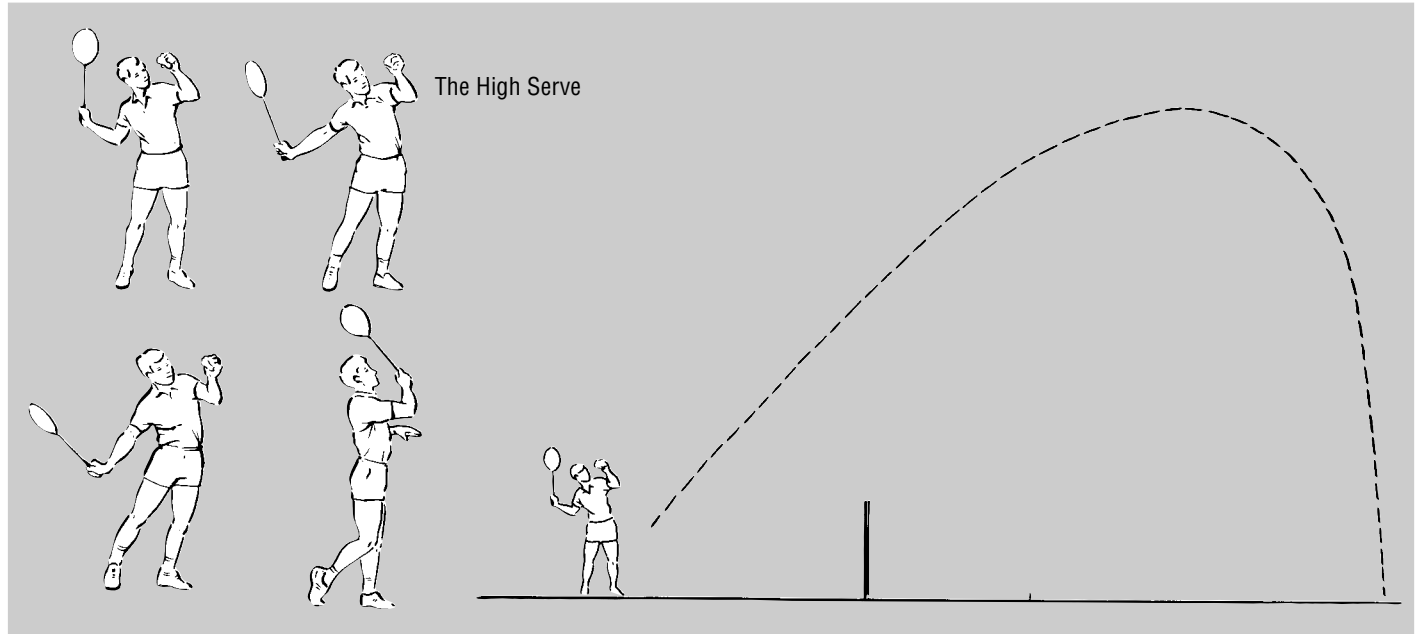

Figure 2.21

Student Check

- Grip
- Use of cocked hand
- Eye on shuttle on contact
- Angle of racket face
- Weight transference
- Follow through
- Laws.

Observation Point

- Check that the player is using a full underarm throw with a whip action.

Development

After executing a high serve in a game of singles, the player moves to the appropriate court position (see Figure 2.23). This player has served close to the centre line, and so has taken up position straddling the centre line.

Task 11: Target Serve (High)

Activity The player works alone using the high serve and (see Figure 2.22) aims for the targets on the other side of the net.

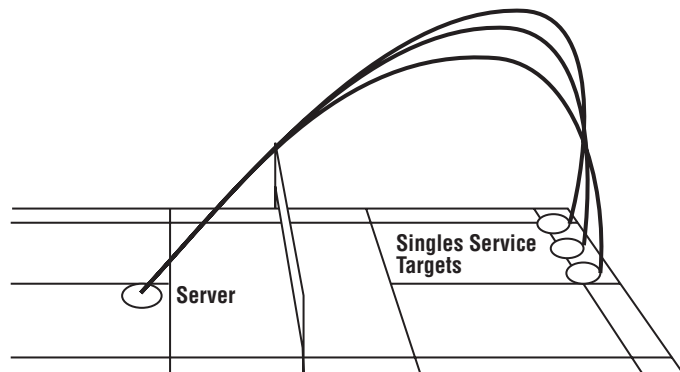

Figure 2.22

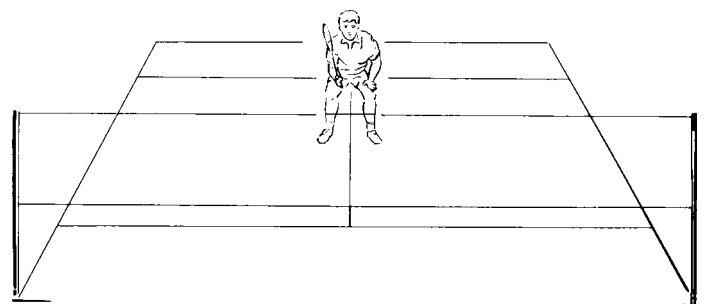

Figure 2.23

Students should understand the principle of returning to base and facing the shuttle, alert and ready for the next move in the game.





Task 12: Serve and Receive of Serve (see Figure 2.24)

Activity In order to make the teaching of the serve more realistic, students combine the serving practice with a receiving practice.

In twos – Player 1 serves high to Player 2 who returns with a downward hit.

Player 1 plays a return to move Player 2 into a space; (a) stop and repeat (b) play out the rally.

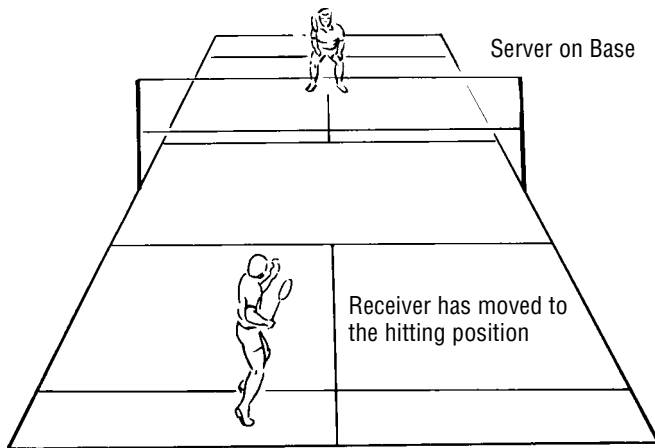

Figure 2.24

Development A conditioned game.

Activity The players play a game of singles starting each rally with the high serve only.

Stroke : The Low Serve

Description Forehand Serve (see Figure 2.25) and Backhand Serve (see Figure 2.26).

Aim To force the opponent to play a lifted return.

Task 13: Target Serve (Low)

Aim To develop accuracy of serve.

Activity The player works alone serving to 3 targets (see Figure 2.27).

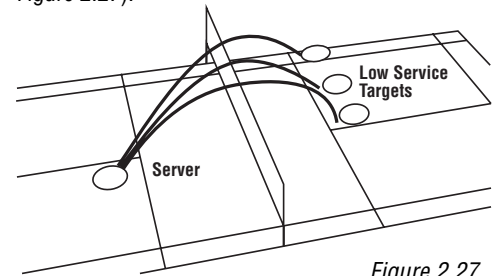

Figure 2.27

Staff Notes

- Use a short push action.
- Keep the hand cocked.
- Try the shortened grip.

Development A conditioned game.

Activity

Play singles starting each rally with the low serve only.

Guided Discussion

Consider the relative values of the high and low serves in singles.

Stroke: The Flick Serve

Description

A deceptive serve played with just sufficient height to clear the receiver.

Aim

To put an opponent, who is threatening the low serve, under pressure. (Mainly in doubles game.)

Student Check

- The approach should be identical to the low serve.
- The uncocking of the hand should be left as late as possible.

Figure 2.25



Short serve trajectory

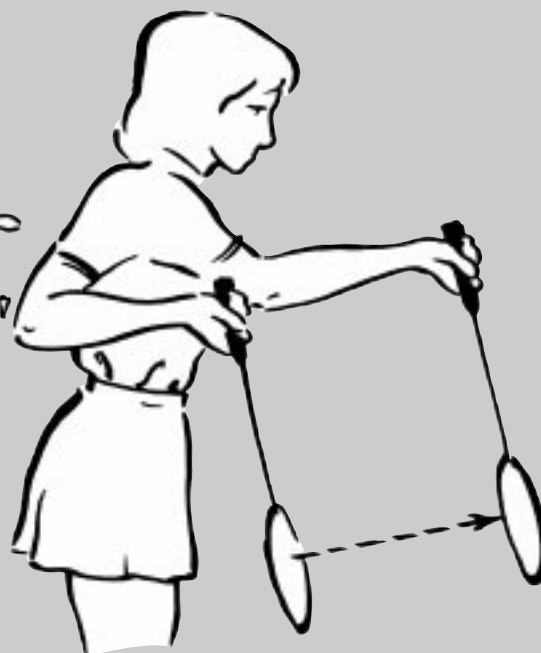

Figure 2.26





Task 14

Activity Place targets just inside the doubles service line for practising this stroke.

Development

- In twos – Practise serve and receive, using low or flick serves.
- Play doubles starting each rally with a low or flick serve.

OVERHEAD STROKES

There are three overhead strokes, each of which has different methods of application.

Smash long/steep

Drop fast/slow

Clear defensive/standard/attacking

All of these can be played on the forehand or backhand.

See Figure 2.28 below:

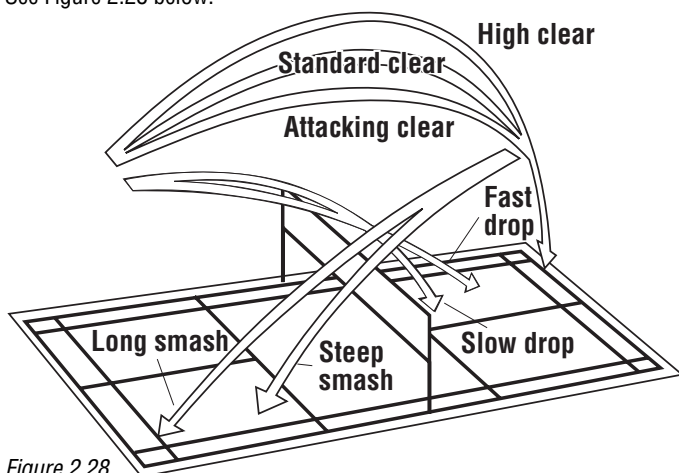

Figure 2.28

All overhead strokes should be approached in the same way. The aim should be to threaten as if to smash and then, as late as possible, adjustments should be made to play another shot, for example a drop.

Student Check

- Body in balance behind the shuttle.
- Grip.
- Cocked hand.
- Eye on shuttle.
- Angle of racket face.
- Where to strike the shuttle in relation to the body.
- Weight transference.
- Follow through.
- Recovery of racket and body.
- The player should be aware of the effect of the shot on their opponent's game.

Stroke: The Smash

Description

See Figure 2.29.

Aim

To play a winning shot or to get a weak reply or to get a predictable reply.

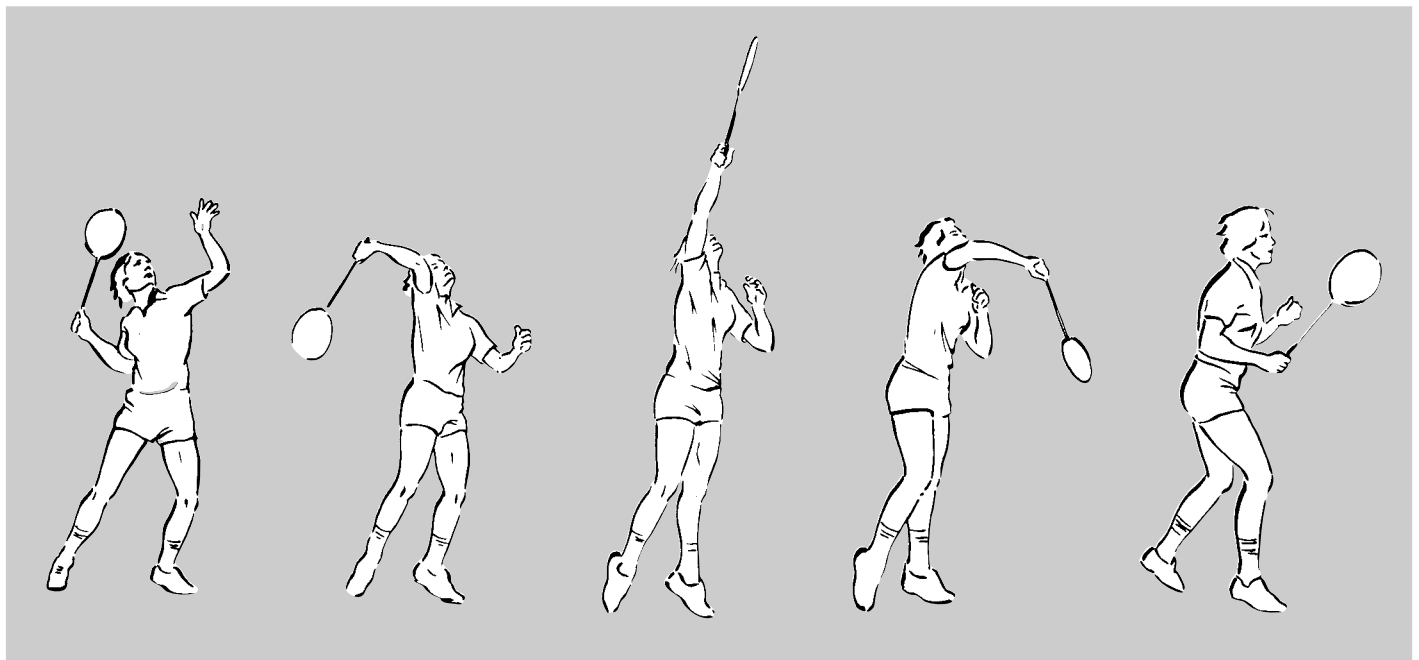

Figure 2.29





Task 15

Activity

Player 1 high serves, Player 2 smashes to hit target, e.g. swimming floats standing vertically (see Figure 2.30).

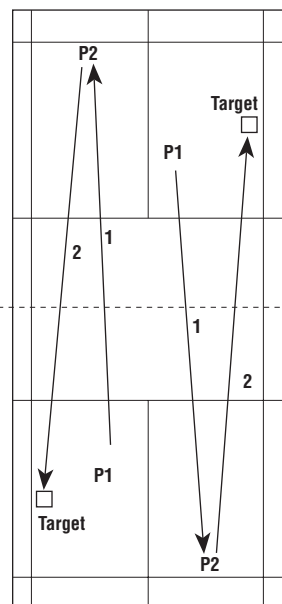

Figure 2.30

Staff Notes

- Encourage an overarm throw with the feeling of a whip action.
- The power comes from: turning the body, rotating the forearm, uncocking the hand.

Guided Discussion

Consider these aspects of the smash:

- angle: flat or steep
- placement: at the body or into space
- power: full or part.

Development

Play singles with the high serve and the smash as the opening moves.

Stroke: The Drop Shot

Aims

To play a winning shot.

To make an opponent reach down low with their racket.

To open up a space for the next shot.

Task 16

Activity

Player 1 serves high, Player 2 hits downwards to mid or forecourt.

Staff Notes

- Remind students to prepare as for smash; then use tap or push action.

Guided Discussion

What advantages can be gained by preparing as if to play a smash?

Development

Play singles with the high serve and the drop shot as the opening moves.

Stroke : The Clear

Aims

To move opponent into rearcourt, so as to open up a space for the next shot.

To put player under pressure in the rearcourt.

To create time.

Task 17

Activity

In twos – Player 1 serves high, Player 2 practises high clear.

Staff Notes

Ensure that the players use a fast overarm throw with the feeling of a whip action.

Guided Discussion

Consider the aims of this shot. Which type of clear would you use to achieve each one? (see Figure 2.28)

Development

Play singles with the high serve and the clear as the opening moves.

STROKES FROM THE FORECOURT

Stroke: The Net Kill

Description

See Figure 2.31a/b.

Aim

To play a winning shot.

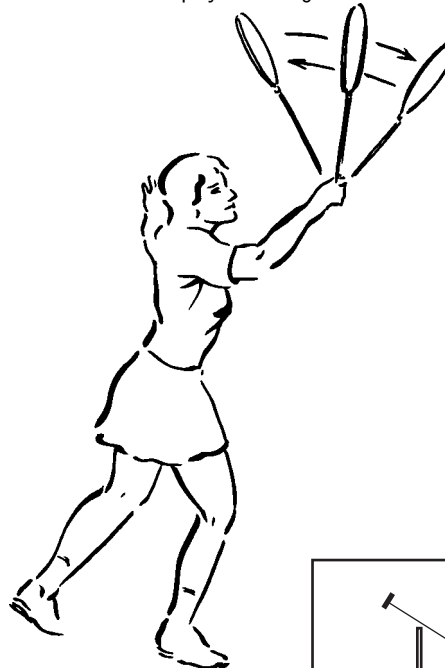

Figure 2.31a

Figure 2.31b

Student Check

- Shuttle position.
- Racket up at tape height for attack.
- Grip – finger control – hand cocked.
- Small racket head action.
- Body – alert and balanced.
- Where to strike the shuttle in relation to the body.

Task 18

Activity

Hand feed using an underarm throw to provide the opportunity of a net kill.

Staff Notes

Encourage a small hitting action to create the feeling of a tap with a rebound action.

Guided Discussion

Consider the laws of the game relevant to this stroke.



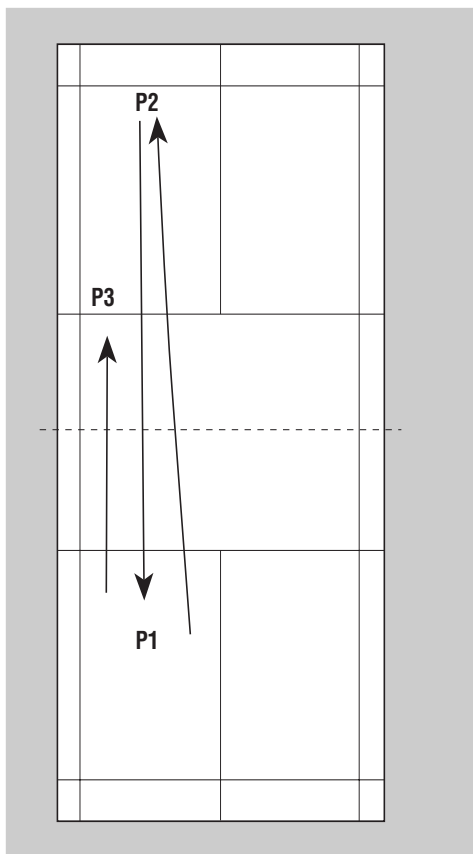

Figure 2.32

Development

In threes (See Figure 2.32 above) – Player 1 serves high; Player 2 returns with a downward hit; Player 1 replies with a push to the net; Player 3 hunts for the chance to play a kill at the net.

Stroke: The Attacking Lob

Description

See Figure 2.33 a/b.

Aim

To get the shuttle into the rear court, behind the opponent.

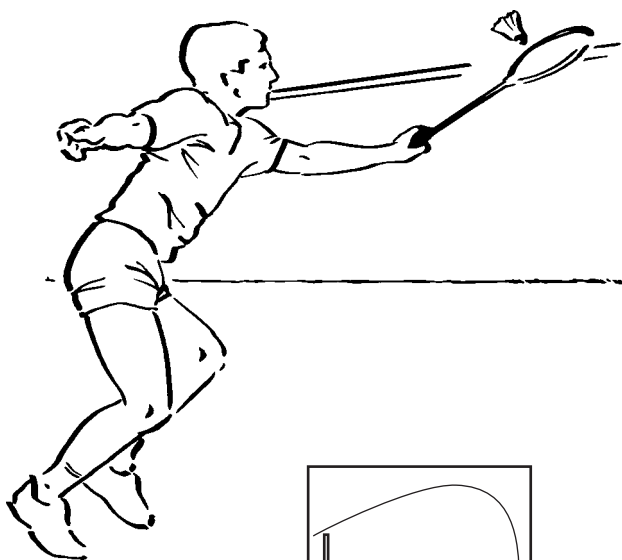

Figure 2.33a

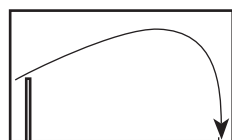

Figure 2.33b

Student Check

- Grip.
- Meeting the shuttle early by stepping towards it on the racket foot.
- Angle of the racket face.
- Action of the racket head.

Task 19

Activity

In twos – Player 1 hand feeds the shuttle to make Player 2 hit from just below net height.

Staff Notes

- Teach backhand first.
- Use a tap action.

Guided Discussion

How would you draw your opponent into a position that would enable you to use the attacking lob effectively?

Development

Try out your ideas in a game of singles.

Stroke: The Net Shot

Description

See Figure 2.34.

Aim

To play a winning shot.

To set up a winning opportunity.

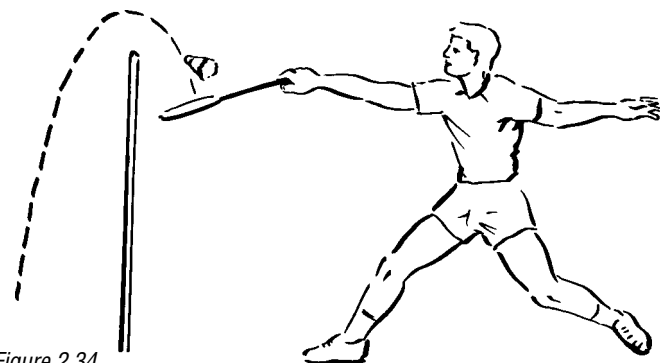

Figure 2.34

Task 20

Activity

In threes – Players 1 & 2 hand feed from close to the net for Player 3 to play: a backhand net shot, a forehand net shot.

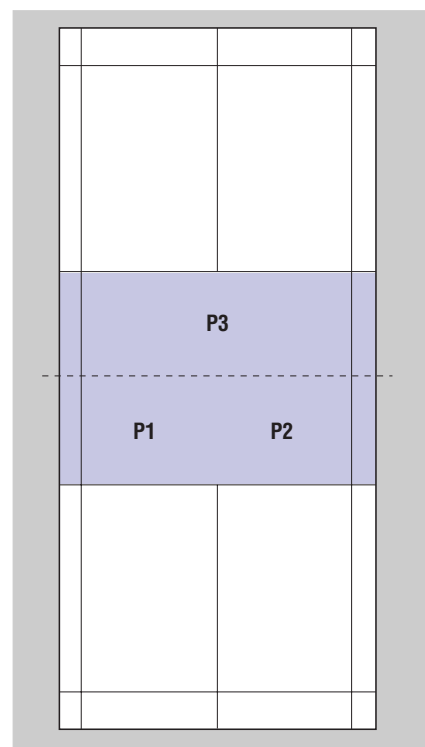

Figure 2.35





- Staff Notes**
- Encourage players to push the shuttle gently upwards and forwards from close to the top of the tape.
- Guided Discussion** Compare the angle of the racket face for a straight net shot and a cross-court net shot.
- Development** Play 2 v 1 using a low serve followed by play limited to the area between the net and the front service line (see Figure 2.35).

DEFENSIVE AND COUNTER-ATTACK STROKES

In playing these strokes there is a basic defensive stance (see Figure 2.36).

- Student Check**
- Hold racket in the ready position.
 - Wait with backhand grip.
 - Step onto racket foot for shuttles wide to right or left.
 - Play off the nearest foot for shuttles close to body.
 - Get low for the shuttle, using a balanced lunge out sideways or a half squat from in front.

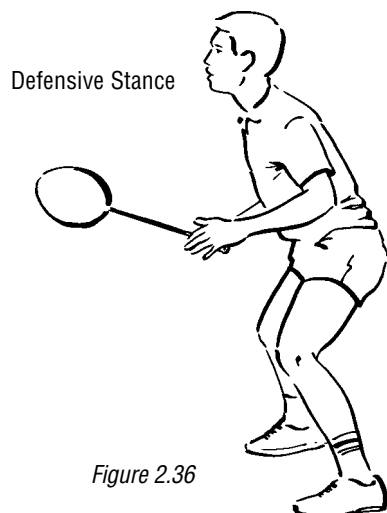

Task 21

Activity In twos – Player 1 hand feeds to make Player 2 contact the shuttle low down in the forecourt.

Staff Notes Encourage the feeling of an underarm whip action.

Guided Discussion Where and how would you position yourself on court after playing the defensive lob?

Development In twos – Player 1 is the feeder in the rear court who uses overhead strokes to move Player 2 in the opposite half court. Player 2 must hit the shuttle back to Player 1, trying to make full use of the defensive lob and clear to create time.

Stroke: Block to the Net

Description See Figure 2.38 a/b.

Aim To return an opponent's attacking stroke low over the net with the objective of regaining the attack.

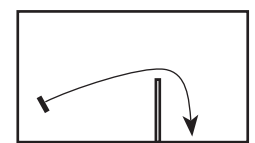
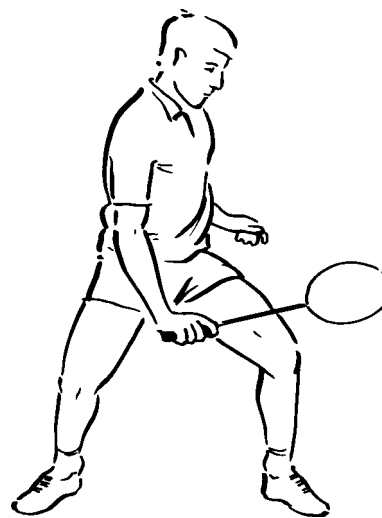

Stroke: The Defensive Lob

Description See Figure 2.37.

Aim To create time.

Figure 2.37

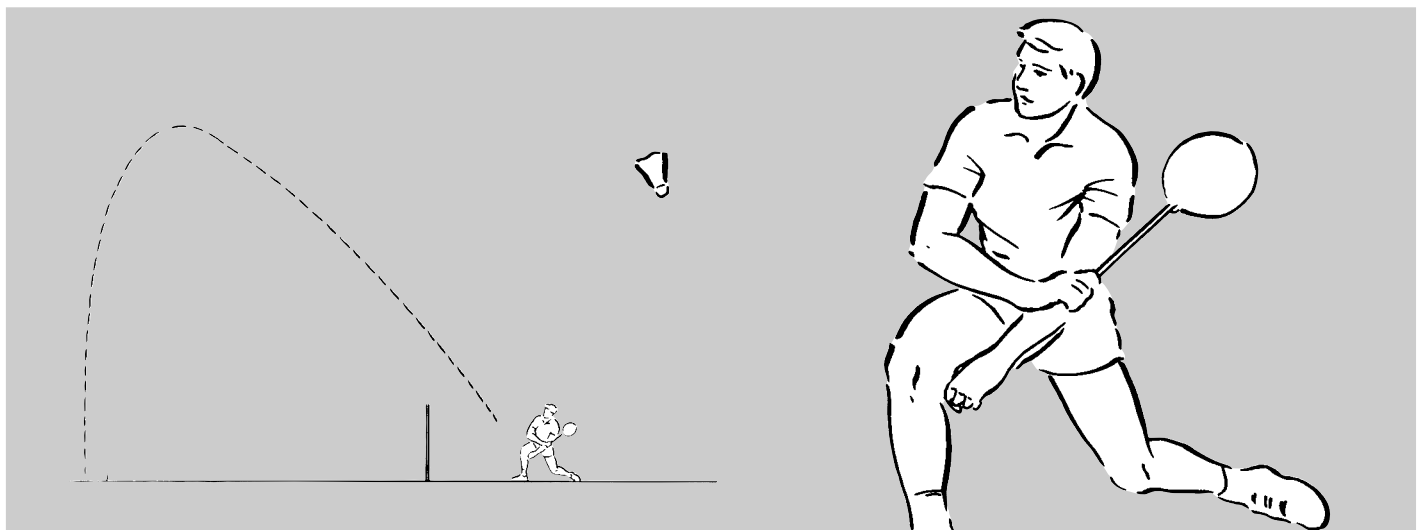



Task 22

Activity In twos – Player 1 hand feeds, throwing the shuttle downwards at the hitter in the midcourt who pushes the shuttle back low over the net to the feeder.

Staff Notes Check that:

- player blocks with the racket head above the hand
- player hits shuttles from in front of the body on the backhand face of the racket
- player changes to forehand grip as necessary.

Guided Discussion Why is it important to wait with a backhand grip?

Development In twos – Player 1 serves high to Player 2 who hits downwards with a steep angle. Player 1 blocks the shuttle back low over the net. Player 2 travels towards the forecourt and plays a net shot. The practice can either stop and be restarted, or can become a continuous drill with the shuttle being lobbed up towards the rear court.

Stroke: The Drive

Description See Figures 2.39, 2.40, 2.41.

Aim To return an attacking stroke low over the net to make an opponent hit the shuttle from low in the rear court.



Figure 2.39

Task 23

Activity In twos – Player 1 hand feeds using a “dart” type throw along the side tramlines. Player 2 turns from the centre of the court and steps onto the racket foot to hit the shuttle flat and fast over the net and then returns to the centre of the court.

Staff Notes The feeder should crouch, kneel or sit with eyes below net height, to avoid being hit in the eye.

Guided Discussion Examine the starting position for the backhand drive to ensure that the forearm rotates in the hitting action (see Figure 2.40).

Development Player 1 serves high to Player 2 who replies with a strong downwards hit. Player 1 drives the shuttle back across the net and the rally continues until the point is won. The shuttle must not be lifted except for the preliminary serve.

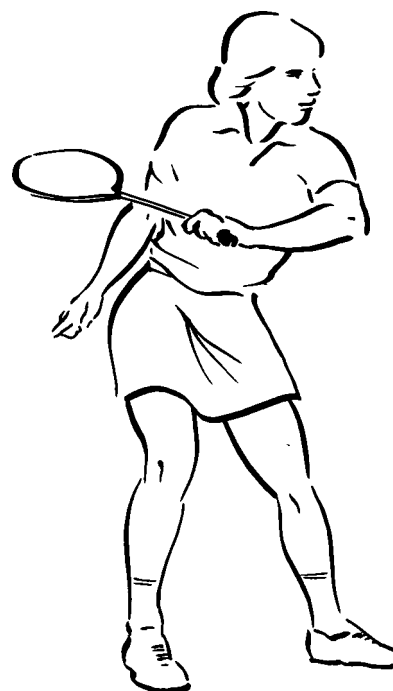

Figure 2.40

Stroke: The Midcourt Push

Description See Figure 2.41.

Aim To return an attacking stroke low over the net to make the opponent hit the shuttle from below net height in the midcourt.

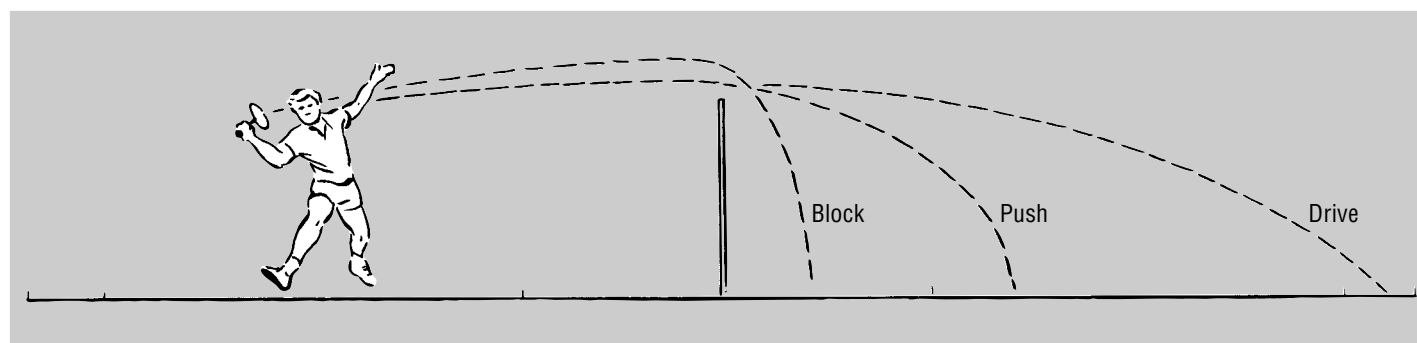

Figure 2.41





Task 24

- Activity** In twos – rally from midcourt to midcourt, hitting the shuttle along the side tramlines.
- Staff Notes** Prepare as for drive. Push the racket head along the line of flight.
- Guided Discussion** Discuss the value of this shot against two opponents in the attacking formation.
- Development** In fours – take up an attacking formation (front/back) on both sides. The front players begin to rally as in the practice above, but make subtle changes in the length of the push to try to tempt both opponents to go for the same shuttle.

STROKES PLAYED FROM THE REAR COURT BACKHAND SIDE

These strokes can be played:

- a) Round the head (see Figure 2.42).

Footwork

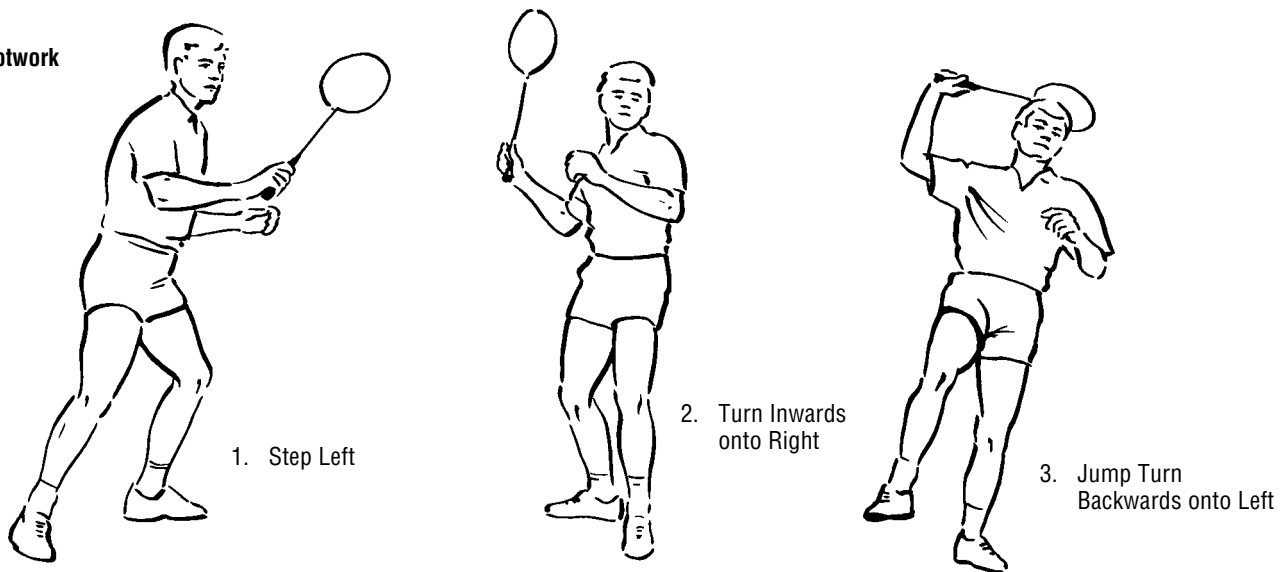

Figure 2.42

- b) With an overhead backhand (see Figure 2.43).

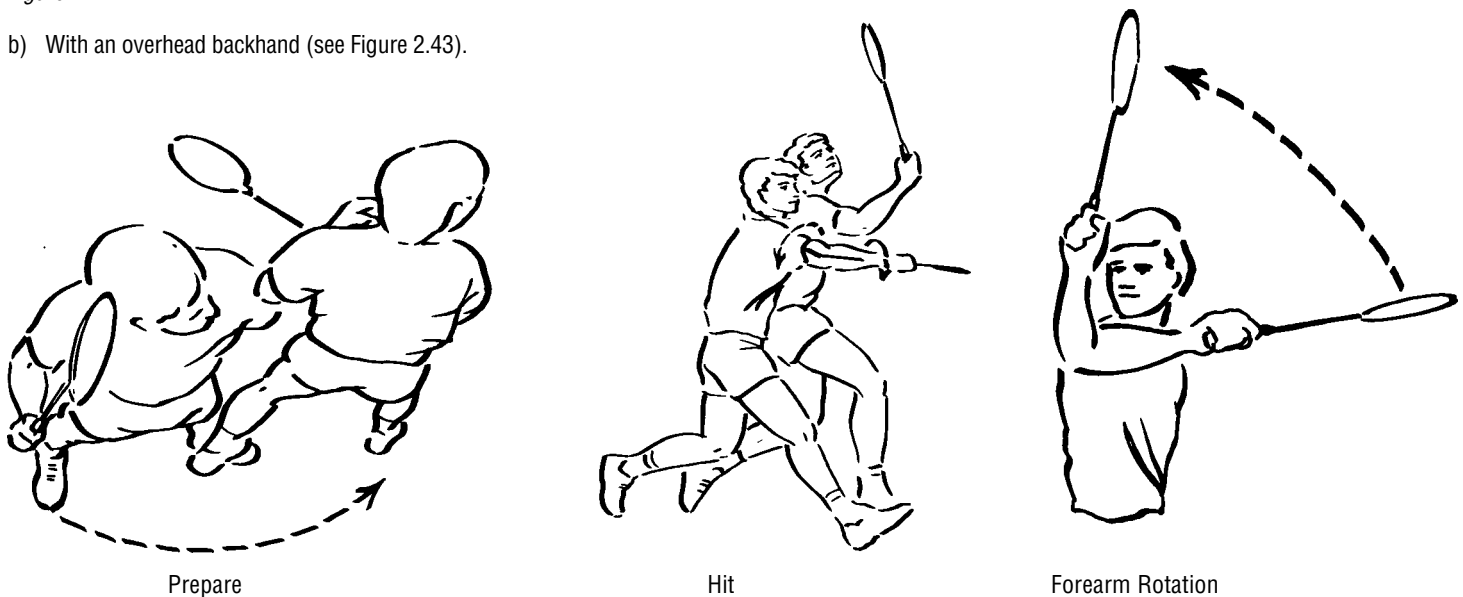

Figure 2.43





Staff Notes

- If using round the head hitting action, the shuttle is hit off the non-racket foot.
- For backhand strokes played from behind the body, a multi-purpose grip is used.

When developing these strokes, as with the other strokes, they may be taught:

- in isolation to practise good technique;
- in a modified game-related practice to understand the effect.

STRIKING THE SHUTTLE WITH AN OBLIQUE HITTING ACTION

Description

See Figure 2.44.

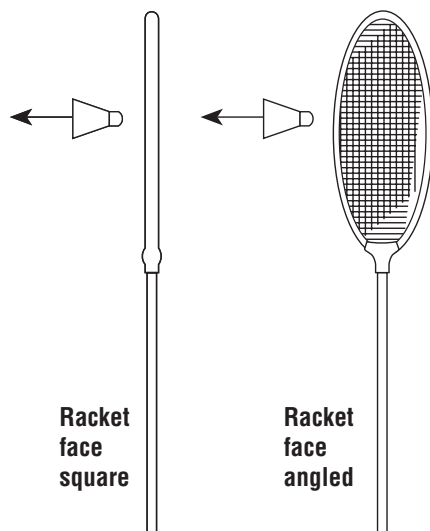

Figure 2.44

Activity

To develop this skill students should experiment with the alternative to hitting the shuttle with the racket face flat, i.e. at right angles to the intended flight pathway. This is to strike the shuttle with an angled racket face (see Figure 2.45).

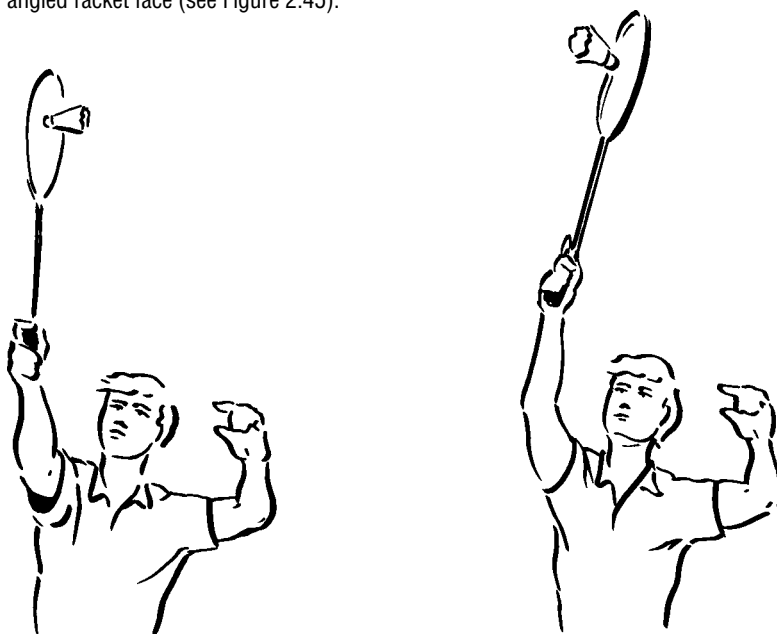

Figure 2.45

Staff Notes

Before moving on to the above, students should master the basic flat-faced action.





UNIT 3 Developing the Game

TACTICS

The basic principle of tactics is to play “the right shot to the right place at the right time”. Tactics will vary according to the level of skills of the players.

Tactics are based on:

- the position of the shuttle
- the stroke options open to the player(s)
- the reasons for stroke selection
- the effect of the shot on opponent(s).

THE SINGLES GAME

Awareness of the effect of the shots (tactics) can be developed in a feeder/worker practice in which the feeder is constantly making decisions in a non-pressure situation.

Task 1

Activity

The feeder in the rear court moves the player around in the opposing half court. The player must hit the shuttle back to the feeder. The feeder selects shots to prolong the rally and makes mental notes about the worker. For example:

STRENGTHS

- Covers the court easily
- Gets into a balanced position to play the shots
- Maintains quality of shot, i.e. good length
- Is fit
- Stays calm

WEAKNESSES

- Struggles to cover the court
- Has poor balance in some areas of the court
- Struggles to hit a good length from some areas
- Tires easily
- Shows frustration

Task 2

Activity

As in Task 1, but the feeder tries to win the rally at the first opportunity and notes the effect on the opponent. The feeder can use deception to try to wrong-foot the player.

Guided Discussion What is involved in producing deceptive shots?

Tasks 3 and 4 as for 1 and 2 except:

The feeder operates from the midcourt so that the player has to hit down, flat or low.

Task 5

Activity

Play a game adopting a plan to play to own strengths and opponent's weaknesses.

Development

Half court singles is a useful development game in which players learn to exploit an opponent using the length of the court. Timed games followed by rotating one half-court can ensure a variety of opponents, and results can help in matching players of similar ability for full-court singles.





THE DOUBLES GAME

Players may need to slow the game down and play co-operation doubles to learn court positioning in relation to:

- a) the intention of the shot played from their side;
- b) positioning with partner to cover possible replies.

Sections of the game with appropriate court positioning can be rehearsed and then put back into the whole game. For areas of responsibility for players in attacking and defensive formations see Figure 3.1.

Staff Notes

- For starting positions in tasks 6-9 see Figure 3.2.

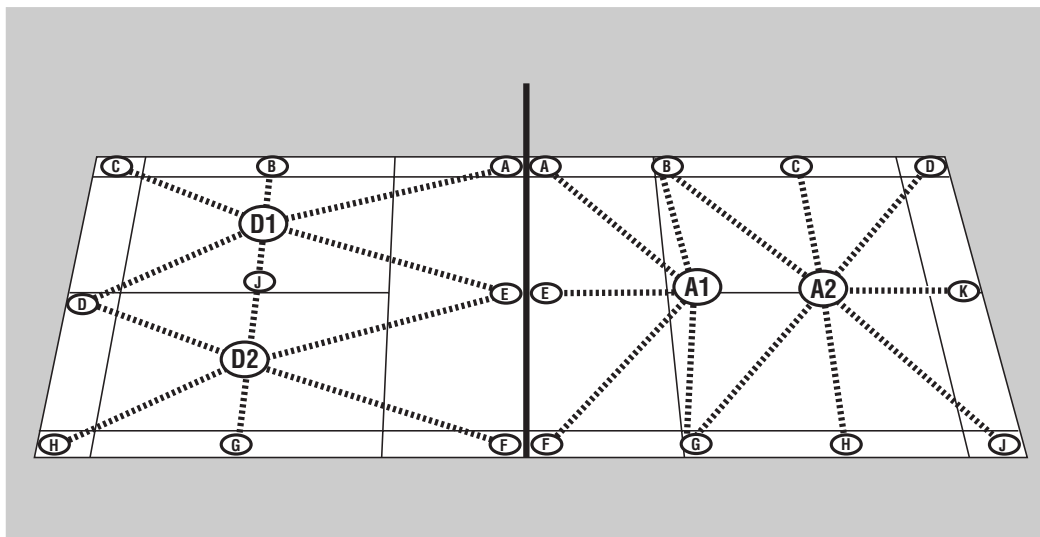

Figure 3.1

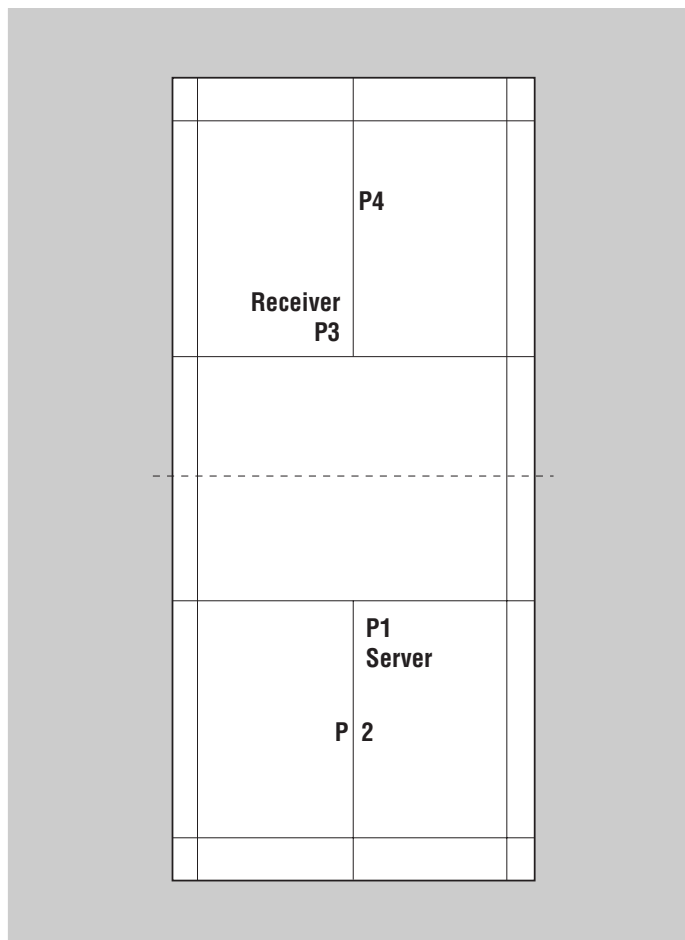

Figure 3.2

Task 6

Activity

Player 1 serves high and takes up a sides defensive position with Player 2. Players 3 and 4 move from receiving serve positions to an attacking front/back formation and must play a downward shot. Players 1 & 2 try to hit low into a space.

Staff Notes

- Each player has 5 successive serves. The practice stops after the 4th shot in each rally.

Guided Discussion

Which side had the advantage after the 4th shot and what position had that side taken up?

Development

Play the rallies out. (Tasks 6-10)

Task 7

Activity

Player 1 serves low and takes up a front attacking role with Player 2 behind.

Player 3 returns with a low placement. The rally continues for 4 shots.

Guided Discussion

Discuss the merits of the various positions it is possible to adopt after the return of serve.

Task 8

Activity

Player 1 serves low and looks for replies around the net area. Player 3 replies with a net shot. A co-operative net rally follows until Player 1 lobs the shuttle high to the rear court and takes up a defensive role in one half-court. Player 2 moves into the adjacent half-court. Stop the rally after the lob; check all positions (see Figure 3.3).

Figure 3.3

In defence, players should take up a position so that they are equidistant from the shuttle within the angle of returns, facing the shuttle.

Angle of return with line dividing the angle of return

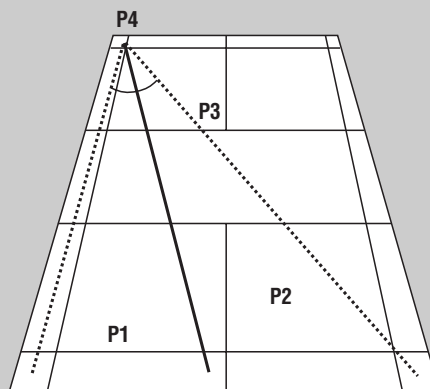



Guided Discussion

To which side should Player 1 move back?

Staff Notes

- Player moves back to the nearest half-court.
- From a central court position, the player moves diagonally away from the lifted shuttle.
- Lifting the shuttle diagonally gives the player longer to retreat and may attract a reply to a partner under less pressure.
- This is useful if the partner has a better defence.

Task 9

Activity

Player 1 serves low.

Player 3 lobs the shuttle to the rear court.

Player 2 clears the shuttle.

Guided Discussion

Examine the court positioning after each shot and discuss the advantages to be gained from the different positions.

Task 10

Activity

All 4 players rally flat in a sides position until Player 1 blocks low over the net to the centre and follows in.

Guided Discussion

Why does Player 1 follow in?

What are the advantages of blocking to the centre?

Staff Notes

- Player 1 now covers quickest replies.
- Doing this may cause the opponents to hesitate.
- A reply down the sides is not so easy because of the angle.

MIXED DOUBLES

In attack

Girl's role:

- Cover the front part of the court.
- Keep the shuttle low on the opponent's side of the net.
- Kill at the net whenever possible.
- Try to get a lifted shuttle for partner.

Boy's role:

- Hit down whenever possible.
- Placement shots should be used to create spaces.
- Use power to create a winning shot or to get a weak reply for partner.

In defence

Girl's role:

- Drop back to cover the cross court smash.
- Move back into the front part of the court at the first opportunity of regaining the attack.

Boy's role:

- Be ready to cover the straight smash.
- Play a shot to regain the attack.

Practices can be set up to develop the specialist skills required by each player.

REMEMBER

The basic principles:

- Whenever possible get the shuttle low on the other side of the net (see Figure 3.4).
- Develop an aggressive approach, but vary placement and power.
- Treat good shots with respect, but try to reply with a good shot from your side to increase your chances of winning.
- Be prepared to rally until you get the chance to play a winning shot.
- Get to the shuttle early.

Attempt to develop the above principles both in serve and receive practice and in practice games.

Once doubles players have developed a basic understanding of attack and defence principles, the game can be played faster and with a competitive rather than a co-operative approach.

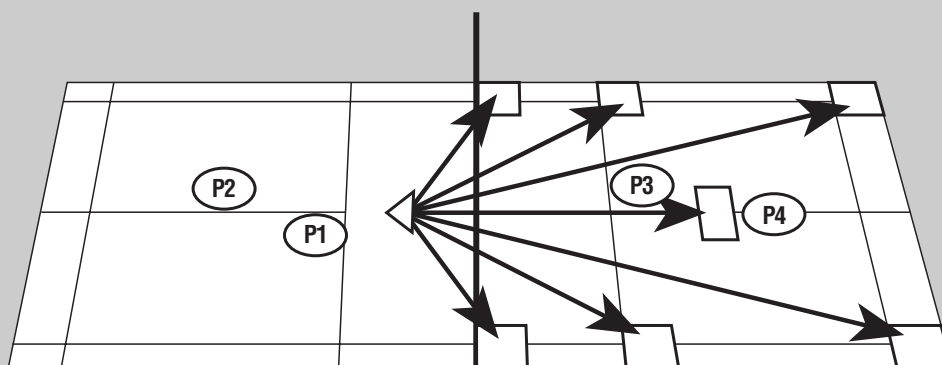

Figure 3.4

Areas to attack in doubles when receiving a low serve.





DECEPTION

Deceptive play with a shuttle (parachute) differs from that with a ball (sphere), but it is still possible to create problems for opponents, and could include:

- disguising intention of stroke
- sending 'wrong' signals
- 'wrong-footing' opponents
- deception on use of length and width of court
- use of racket face (flat or angled)
- change of pace of moving and of hitting.

The light racket is suitable for various forms of deception. The effective part of the stroke can be left as late as possible; additionally, parts of the body can be used in deception.

Some forms of deception can increase errors. Ideally when using deception the player should be:

- balanced
- relaxed
- watching the shuttle carefully.

Deception in a game context is more effective if used sparingly, combined with "bread and butter" play.

Task 11

Activity

Hit a variety of overhead forehand shots with identical preparation. Test the effect against an opponent, e.g. clears, then drop (use of length).

Task 12

Activity

Deliberately over-emphasise a "signal"; for example, prepare for "big smash", then play drop shot.

Task 13

Activity

Play overhead rally from rear court to opponent in opposite forecourt. Try to get shuttle on floor in opponent's area, using a variety of straight and cross-court deceptive shots (use of width).

Task 14

Activity

Use of paired shots as illustrated in Figure 3.5. For example straight clear to T1, cross-court drop to T2.

P1 takes up position in rear court and clears to opponent, selecting appropriate time to hit deceptive cross-court drop.

P2 returns all shots to P1 position.

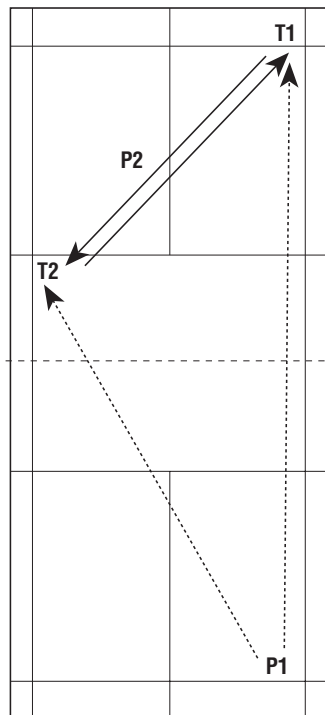

Key: T = target
P = player

Figure 3.5

THE COMPETITIVE GAME

It is useful to have a match plan, particularly if you are playing stronger players.

An example of a match plan might be:

To analyse relative strengths and weaknesses in terms of:

- the overall game, e.g. skills, fitness;
- any key part of the game, e.g. serve, backhand.

Draw on information:

- from previous encounters;
- from observation of opponents against other players;
- from astute observers, e.g. ask coach/teacher for advice.

Pay particular attention to service, for example:

- length in singles;
- accurate low serve in doubles combined with deceptive flick serve.

In doubles work out with partner:

- how to outmanoeuvre opponents;
- the relative strengths of each individual opponent.

Students should be made aware that game plans must be flexible, and capable of change if they do not work.





UNIT 4 Assessment of Badminton

Areas to be assessed: Technique – racket and body skills
Tactical awareness
Laws
Scoring
Fair play
Knowledge of the game

Means of assessment: Projects, knowledge relating to the game
Worksheets, on topics such as the laws of the game
Practical work

Levels of Practical Assessment

Students will fall within different grades or levels of ability. Grading students in practical work is a highly skilled task, and the following are suggested guidelines which may help staff to categorise their students into different groups.

EXCELLENT

Can perform all strokes and movement with quality. Shows a clear understanding and has the flair to produce surprise elements if needed.

VERY GOOD

Applies strokes, movement and tactics in the game, but sometimes lacks consistency.

GOOD

Can perform strokes, movement and tactics in continuous controlled practices, but in the game, although tactically aware, skills break down under pressure.

AVERAGE

Can demonstrate strokes and movement in isolation, but has limited success in the game.

BELOW AVERAGE

Can hit on forehand and backhand, but with a limited stroke range, and lacks quality of movement. Has little success in the game.

WEAK

Limited and erratic skills, clumsy, poor co-ordination, finds it difficult to rally.

POOR

Makes little effort.

PRACTICAL ASSESSMENT

It is possible to assess boys and girls in the same groups although relative strengths may make a difference to the outcome of a game. Players with early experience of the game may have to be considered, and it is therefore desirable to group players into similar-ability groups for assessment. Teacher knowledge plus results from competition play should make this possible.

Time may not permit assessment in all three disciplines of the game, and so it is suggested that a player is assessed in singles and either level or mixed doubles.



**Task 1**

Assessment can be made in a feeder/worker situation, or in a half-court co-operation rally.

Aim

To keep the rally going.

Points to Look for

- Competent use of racket and body skills during conditioned play.

Staff Notes

Players should rotate to play with different players from within their ability group to allow for equal opportunity.

Task 2 Competitive Singles*Aim*

To show effectiveness of movement, strokes and tactics under the pressure of competition.

Points to Look for

- Accuracy.
- Consistency.
- Use of space/stroke selection to exploit opponent.
- Ability to read the game and to use effective movement in order to be in the right place at the right time.

Task 3

(This can be assessed in conjunction with Task 2.)

Aim

To show a practical application of fair play.

Points to Look for

- Competes with dignity.
- Applies the rules.
- Is courteous to partner, opponents, officials, helpers.

Task 4 Scoring/Laws*Aim*

To demonstrate the knowledge of the scoring system and the laws of the game.

Staff Notes

This can be assessed in conjunction with Task 2 with a third player scoring.

Task 5 Level or Mixed Doubles*Aim*

To show an understanding of the use of strokes and movement when combining with another player.

Staff Notes

Players should compete in fours of similar ability.

Points to Look for

- Working as a team.
- Court coverage.
- Playing for each other.
- Effectiveness of serve and return of serve.
- Ability to get and maintain attack.
- Control of shuttle in defence with a view to regaining attack.

Task 6 Scoring/Laws*Staff Notes*

This can be done in conjunction with Task 5 by an off-court player. This allows the on-court players to concentrate on the game.

ONGOING ASSESSMENT

During both curriculum time and in club and other activities, the following guidelines may be used as part of continuous assessment of student progress and performance.

CATEGORIES	PERFORMANCE CRITERIA	COMMENTS/ADVICE
APPEARANCE	Smartness Alertness Appropriate clothing Personal hygiene	
ATTITUDE AND PERSONALITY	Positive/committed Interested/enthusiastic Takes initiative Has sense of humour Takes care Calm Active Confident Friendly/co-operative Helpful Receptive Patient/tolerant Gets on easily with others	
PLAYING ABILITY		
RACKET SKILL	Range of strokes Racket control Stroke cycle Style/fluency Accuracy/control/consistency	
BODY SKILL	Range of movement Control Style/fluency/lightness, gracefulness/mobility, smoothness/quickness/agility	





UNIT 5 The Formal Game

SINGLES	LEVEL DOUBLES	MIXED DOUBLES
2 players of the same sex compete.	2 pairs of players (same sex) compete against each other.	1 male and 1 female combine as a team to play against another mixed pair.

The Court

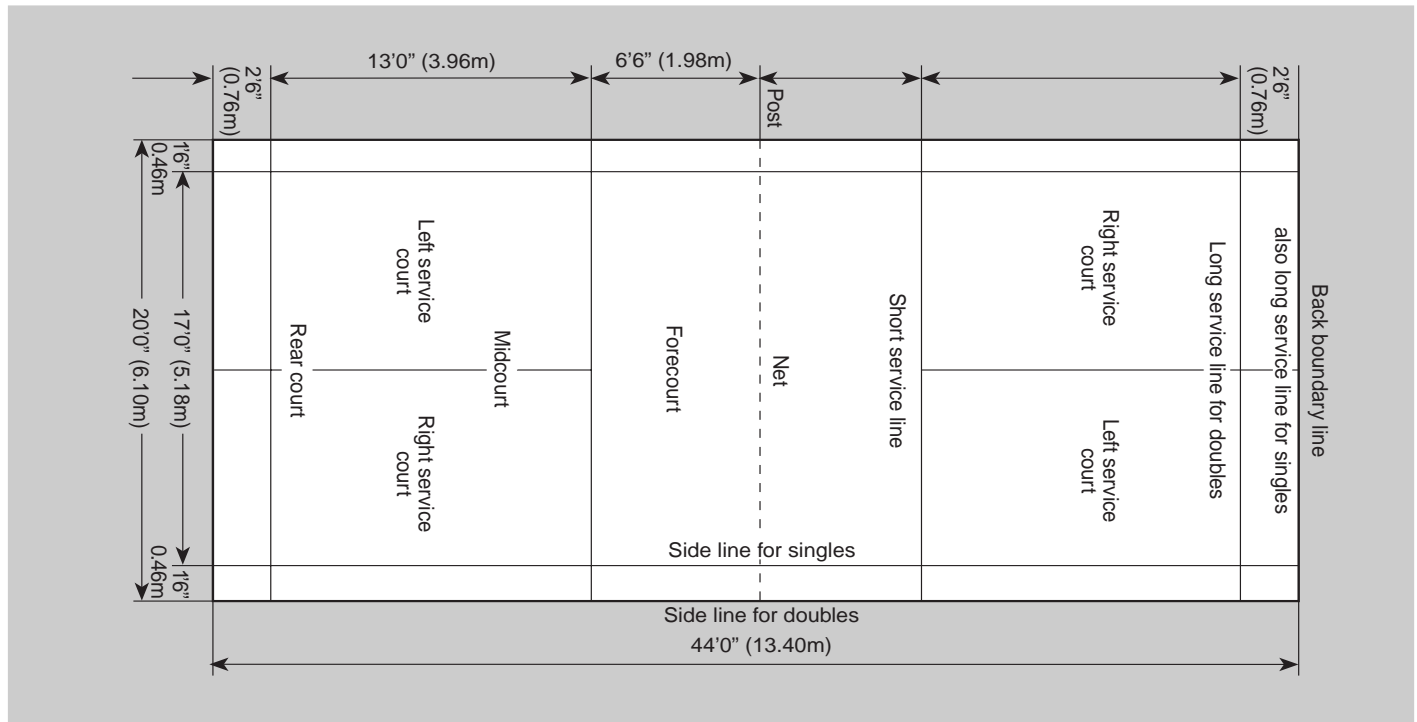

Figure 5.1

MATCH PLAY

Matches are played as follows:

LADIES' SINGLES	MEN'S SINGLES	LEVEL DOUBLES	MIXED DOUBLES
Best of 3 games to 11 points	Best of 3 games to 15 points	Best of 3 games to 15 points	Best of 3 games to 15 points

Scoring

Only the serving side can score a point. One player serves until their side loses a rally. In doubles the side serving at the start of the game is allowed only one server first time round. After that each side has a first and second server. Service begins from the right service court, and that person serves or receives from the right hand court whenever their score is an even number, and from the left service court whenever their score is an odd number.





Setting

In a game of 15 points, setting is available at 14-14. The side which first reached 14 points has a choice:
 (a) to continue the game to 15 points i.e. not to 'set' the game
 or (b) to 'set' the game to 17 points i.e. three more points.

POINTS IN GAME	SETTING AT	POINTS NEEDED TO WIN
21	20 – 20	5
15	14 – 14	3
11	10 – 10	3

Setting declined in the first instance is permitted in the same game should a second opportunity arise. Setting is not permitted in a handicap competition when one side gives a start to another side.

Rackets

These can be purchased by the school or by the individual and should take into consideration the needs of the purchaser and the player. Lightweight rackets with a slightly flexible shaft and firm strings as opposed to heavy rackets with soggy strings will increase the players' ability to improve their performances.

Shuttles

Many schools, clubs and leagues use plastic shuttles, although top competition is with feather shuttles. A coloured band indicates the speed of synthetic shuttles: blue for medium speed and red for a faster speed used in colder conditions. The speed of feather shuttles is indicated by the number of grains (weight). To test the speed of a shuttle it should be hit with a full underhand stroke, the contact being made above the back boundary line.

The shuttle must be hit at an upward angle and in a direction parallel to the side lines. A shuttle of correct pace will land not less than 530mm and not more than 990mm short of the other back boundary line (see Figure 5.2).

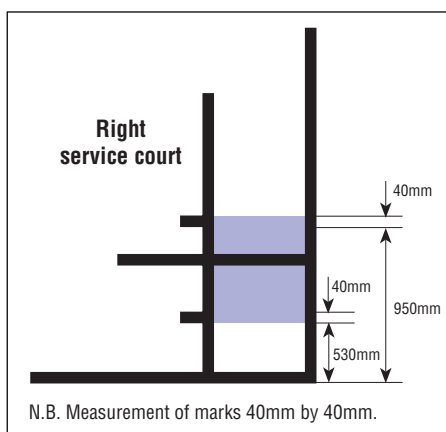

Figure 5.2

Optional Testing Marks for Doubles Court

Clothing

Tournament regulations stipulate whether all-white clothing must be worn, or coloured clothing is allowed.

Footwear

Each individual must choose according to personal taste, but in general badminton shoes should be light in weight, give adequate support and protection and provide flexibility and grip.





OFFICIALS

Referee

Directs tournament and has the final decision in settling any disputes.

Manager of Umpires

Appoints umpires and service judges to individual matches.

Umpire

Checks that posts and nets are correctly placed.

Supervises the toss.

Reports to the referee any violation regarding clothing and advertising.

Supervises the testing of shuttles.

Checks that officials for the match are correctly placed and know their duties.

Decides on by-laws regarding the shuttle's hitting an obstruction.

Announces the match.

Records and calls the score, calling the server's score first.

Watches the receiver of serve and calls any fault relating to the receiver.

Controls play and players.

Service Judge

Responsible for judging that the server delivers a correct service. (For signals see Figure 5.3.)

Line Judges

Responsible for the line(s) assigned. (For signals see Figure 5.4.)

Instructions to Service Judges

5.1 The Service Judge shall sit on a low chair by the post, preferably opposite the Umpire.

5.2 The Service Judge is responsible for judging that the server delivers a correct service (Law 11.1). If not, call 'fault' loudly and use the approved hand signal to indicate the type of infringement.

5.3 The approved hand signals are:



Law 11.1.3 The initial point of contact with the shuttle not on the base of the shuttle.



Law 11.1.3 Whole of the shuttle not below the server's waist at the moment of being struck.

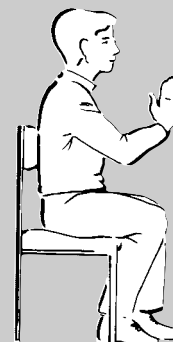

Law 11.1.4 At the instant of the shuttle's being hit, the shaft of the racket was not pointing in a downward direction to such an extent that the whole of the head of the racket is discernibly below the whole of the server's hand holding the racket.

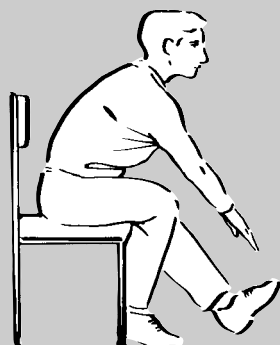

Law 11.1.2 Some part of both feet not in the service court and in a stationary position until the service is delivered.

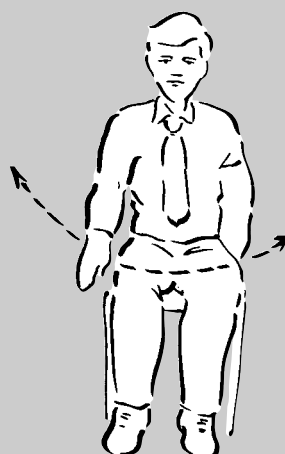

Law 11.1.1, 11.2 and 11.1.5 Undue delay in the delivery of the service.

Once the players have taken their positions the first forward movement of the server's racket head is the start of the service. The movement must continue forwards.

Figure 5.3

SIGNALS FOR LINE JUDGES

Shuttle is out

If the shuttle lands out, no matter how far, call "out" promptly in a clear voice, loud enough to be heard by the players and the spectators and, at the same time, signal by extending both arms horizontally so that the umpire can see clearly.

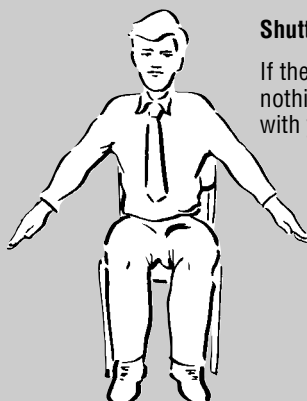

Shuttle is in

If the shuttle falls in, say nothing, but point to the line with your right hand.

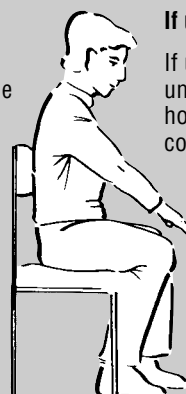

If unsighted

If unsighted, inform the umpire immediately by holding your hands to cover your eyes.



Figure 5.4





UNIT 6 Physical Conditioning

For factors influencing performance, see Figure 6.1.

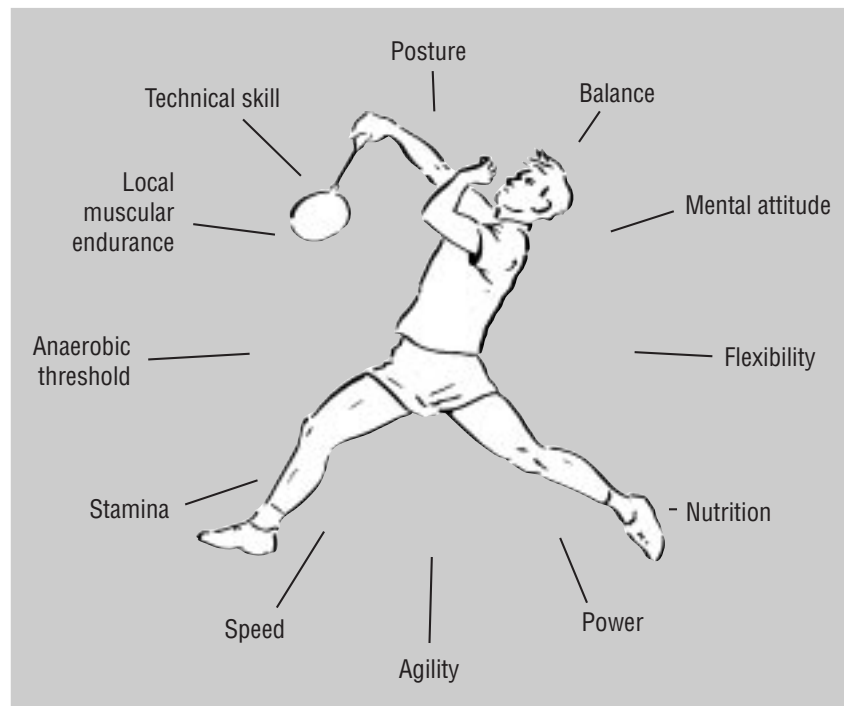

Figure 6.1

PERFORMANCE COMPONENTS

Within any game or sport there are different components which are specific to the activity taking place.

Component	Game Requirements	Training Advice
Balance	Integral part of all activity. Related to the floor but can also apply to jumping.	Develop practical awareness of: centre of gravity, placement of feet, weight distribution.
Posture	Influences balance and recovery. Poor posture may lead to injury.	Incorporate into skill training. Develop awareness of body parts.
Hitting skills	Ability to perform full range of strokes with accuracy, consistency, economy, delicacy, power and deception to and from all parts of the court.	Build up from simple co-operative situations to more complex game-like competitive practices. Integrate with other skills, e.g. body skills.
Flexibility	Needed in turning, twisting, reaching, bending, power hitting. Particularly valuable when attempting difficult returns.	Establish a daily routine, even if no other work is done. Essential for efficiency and injury avoidance.
Local muscle endurance	Long rallies or constant attack puts strain on arm and shoulder muscles and legs.	Circuit training. Resistance work with light weights, high repetitions. Multi-shuttle feeds. Shadow badminton.
Local muscle strength	Used to create explosive action, e.g. fast start, speed to shuttle, stopping from fast movements, jumps, sudden changes of direction.	Resistance work with heavier weights and fewer repetitions. Multi-shuttle feed.





Component	Game Requirements	Training Advice
Stamina (cardiovascular endurance)	Needed to withstand long, repeated rallies, which in tournaments will be followed by further games.	Off-court running, hill running, “co-operation singles”, non-stop games, shadow badminton, shuttle runs.
Anaerobic threshold	Repeated fast rallies with short intervals push players into anaerobic activity.	Build up tolerance to anaerobic bursts through game-related interval speed work. Develop awareness of pace, effect on self and opponent, and ability to play accurately under pressure.
Speed (largely inherited but has skill components)	Speed of whole body movement round court. Change of pace. Getting to the shuttle early. Speed of limb or body-part movement. “Reading” the game and quick decision making. Agility (controlled change of direction).	Practise alertness, fast moving and attacking hitting, with control. Work on relevant body parts and whole stroke cycle. “Groove” in responses by suitable practices, e.g. multi-shuttle feed. Develop anticipation through realistic practice. Study the signals and responses of opponents.

For students (11–16 years) it is advisable to concentrate on skills and tactics, and to develop fitness through play. Beyond this age, additional fitness can be included. Weight training will require specialist advice and guidance.

Periodisation of Training

All training for sport should be designed around the different cycles of the competitive year, which is divided into different periods depending on the number and importance of the scheduled competitions. The example below (Figure 6.2) is for a “double periodised year”, which is planned for a player aiming to peak for the all-England championship in mid-March. Periodisation refers to the division of the year into periods of specific training. The actual year may be a stage in a longer programme, e.g. 5-year plan.

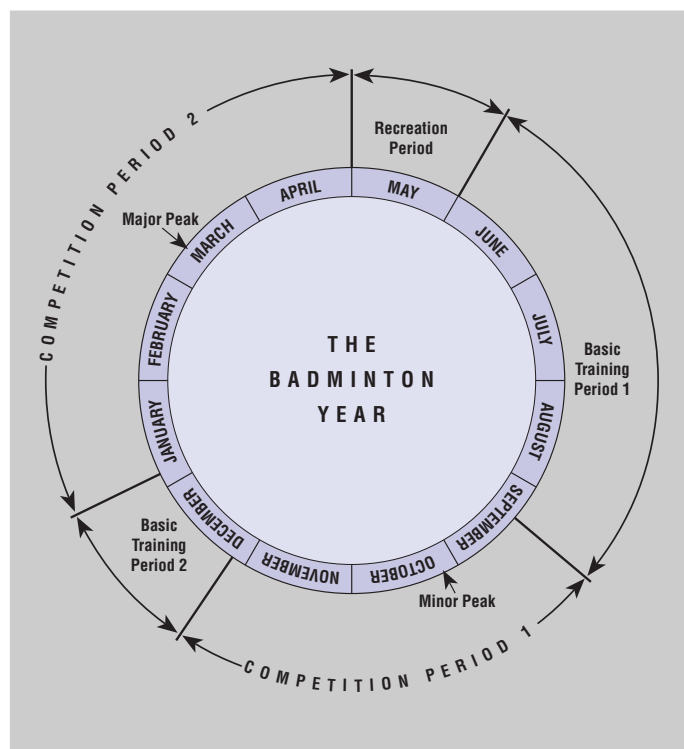

Badminton is played throughout the year, but the tournament calendar in England is based on the game as a winter sport, September – April.

International players may be expected to “peak” at different times, according to when tournaments are held, and some may be playing throughout the year. Such players eventually have to take longer rests to recover; otherwise injuries are likely to occur.

A common system with high-level players is to identify a “target tournament” (e.g. World Championships) and to work backwards from that point, in order to plan their build-up programme. A carefully designed programme will even allow for minor setbacks such as injury or illness.

The aims within a programme may be:

- gaining a competitive advantage
- gaining optimum improvement in performance
- preparing for build-up competition
- preparing for an identified competition climax.

These would be as an individual, as a member of a doubles partnership, or on behalf of a team. These different contexts may influence the programme, and make it necessary to consider and work with other players.

Periods of preparation may be broken down further into: macrocycles (4–6 weeks) and microcycles (1 week), where the daily programme is detailed.

It is impossible to perform continuously at peak level, and so “target dates” must be identified, when the player aims to achieve maximum performance.

Figure 6.2





The year is divided into phases, each with its own emphasis:

Basic Training Period 1	Competition Period 1	Basic Training Period 2	Competition Period 2	Recreation Period
Basic conditioning period for "core" fitness: a) Developing stamina, strength, flexibility Off-court work (e.g. hill running) "Co-operation" singles Changing technique Testing – monitoring progress b) Developing speed, flexibility Interval work Multi-shuttle activity Stabilising technique Practice games Work on tactics/ partnerships	Minor tournament period: Includes minor peak, e.g. county championships where team selection may be decided Continue to work on speed, accuracy consistency Match analysis	Reduced competition period: Short rest Work on conditioning, polishing technique, speed and tactics, according to lessons learnt in previous periods	Minor tournaments period building to a major peak, e.g. National Championships Further minor tournaments Planning Mental tuning Pressure training	Rest and recuperation period: Change of activity Maintaining condition Flexibility Evaluation Planning for next season

The example below is of a 12-week programme for a county level player under 18:

Factors involved	Basic Training Period 1	Weeks 1 – 6	Weeks 7 – 10	Weeks 11 – 12
Lifestyle management		Emphasis on	Each week	
Time		1. Aerobic training	3-5 days	Some game specific
Other interests		2. Anaerobic training	1-2	
Facilities available		3. Strength training	2-3	
Access		4. Technique training	2	
Convenience		5. Flexibility	daily	
Cost		6. Mental training		
		7. Occasional games		
		Weeks 7 – 10		
		Emphasis on	Each week	
		1. Aerobic training	2-3 days	Game specific
		2. Anaerobic training	2-3	
		3. Strength training	1-2	
		4. Technique training	2-3	
		5. Flexibility	daily	
		6. Mental training		
		7. Games		
		Weeks 11 – 12		
		Emphasis on	Each week	
		1. Anaerobic training	1-2 days	Game specific
		2. Speed training	2-3	
		3. Technique training	1-2	
		4. Match play	2-3	
		5. Flexibility	daily	





UNIT 7 Mental Preparation

MENTAL PREPARATION

The player's mental condition is very important both in training and in competition. This subject might be divided into two major areas:

MENTAL ATTITUDE

- Be positive
- Pay attention to the next part of the rally or game
- Concentrate on basic aspects of skills
- Enjoy the contest and the expression of skills
- Stay relaxed, so that muscles can work effectively and with less risk of injury
- If things go wrong, stay calm and concentrate on basics
- In doubles, work as a team, always support each other, accept responsibility for poor play, and then work to avoid repeating it
- Don't be put off by mistakes; concentrate on avoiding more of them
- Set high standards on and off the court
- Prepare beforehand – training, equipment, warm-up.

MENTAL TOUGHNESS

- Whatever the problems, try to overcome them
- Keep skills together under pressure
- Dominate the rallies, and the course of the game
- "If it's hurting me, it's hurting them more"
- Champions are capable of tolerating discomfort
- Exploit their weaknesses; protect your own
- Be even more determined to win the long, tough rallies
- Having gained an advantage, do not lower your standard
- "Even if it seems impossible to win, I will still gain something from the event."

STRESS AND PEAK PERFORMANCE

There is a clear relationship between stress and peak performance, and while some players are "stress resistant", if a player does suffer from stress which creates problems both in training and competition there are techniques which can be adopted, and which staff and player can discuss and apply. It is important to note that mental training is highly individual, and each player will respond differently to different techniques. The ones described below are but a few of the more generally accepted methods.

STRESS REDUCTION TECHNIQUES

1 Model training

Simulate the conditions which cause stress.

2 Relaxation techniques

Tense then relax the muscles.

3 Stress management; desensitisation techniques

Imagine being in the stress situation and coping well.

4 Mental rehearsal

Create a mental picture of producing a badminton stroke.

5 Positive affirmations (what the player says to himself)

For example, I'm fit and feel good and I'm going to win.

6 Satisfaction of psychological needs

One player may like to be in a group, another may like to be alone.

7 The warm-up

Use the warm-up to prepare both physically and mentally.





UNIT 8 Health and Fitness

Badminton players need to be fit to play the game at their level.

It is important that training and competition are appropriate to the age and needs of the player.

The following chart is a suggested guideline of components which can be safely incorporated into a development programme for young people.

Age

Under 10	Racket and body skills, fun games, short badminton
10 – 12	Racket and body skills, flexibility, modified games, games
12 – 14	Racket and body skills, flexibility, aerobic and anaerobic work, games
Post-puberty	Racket and body skills, flexibility, aerobic and anaerobic work, strength, games

There are certain benefits to be obtained from playing badminton:

Physical health:	Mental health:
Improved fitness	Enjoyment and pride in performance can have a positive effect and improve self esteem.

As with all other sports, however, injuries can arise from:

- Poor technique
- Inappropriate equipment – e.g. heavy rackets, poor footwear
- Unsafe environments – e.g. slippery floor
- Incorrect training programme
- Poor preparation – e.g. inadequate warm-up/stretching
- Lack of skill
- Lack of experience – not knowing how far to go/when to stop
- Stress – personal life, unrealistic games/goals
- Poor diet
- Insufficient rest/sleep
- Over-use
- Imbalanced body development – predominantly one-sided sport
- Lifestyle – total physical involvement

As “prevention is better than cure” the following steps should be taken:

- Development of efficient hitting and moving techniques
- Gradual build up of intensity
- Awareness of the player’s growth spurt
- Adherence to safety rules and guidelines

BADMINTON INJURIES

Badminton is a relatively safe game with a low injury record but awareness of game-related problems is still required.

The game is characterised by fast, explosive movements, quick twisting movements, ‘maximum efforts’, long periods of play, likelihood of fatigue, and intermittent play in a match and between matches. It is a duel of skills, of physical and mental effort and of counter attack.

There are particular stresses on knees, ankles, shoulders, calf muscles, thigh muscles and back muscles. Hard training and continuous play can lead to “over-use” injury. Techniques involve explosive leg work, continued quick movements, stress on muscles and tendons (both immediate and through fatigue) created by frequent direction changing, twisting movements, off-balance play, the search for “early” shuttles, the search for height and the stretching for distant shuttles.

Hard floors, slippery surfaces, different court textures and poor visibility which leads to “late” movement are potential problems, as is a swinging racket and a hard-hit shuttle.

Injuries may be encountered which would require medical treatment; as such they are not relevant to a text of this type. If considering providing first aid treatment for such injuries, it is important that this falls in line with both local authority and the school’s own health and safety regulations.





UNIT 9

The History and the Structure of Badminton

The origins of the game are obscure, but badminton is probably based on the human enjoyment derived from hitting or kicking missiles with hands, "bats" or feet as depicted in ancient pottery and carvings, and later engravings, pictures and drawings. Numerous games and pastimes evolved, usually on a continuous rebound principle or passing between partners. Where competition was involved, codes and laws had to be agreed, firstly at local level and then, as travel became easier, at national and then international level. Badminton emerged as a gentle parlour game, but has developed to a level where the world's top players are superb, highly trained athletes.

The characteristics of the modern game are created by the uniqueness of the shuttlecock, the court area, the height of the net and the light rackets.

THE HISTORY

2000 years ago a game with a 'shuttle' was played in ancient Greece and China. The 'shuttle' was hit with feet or bats.

Medieval England	Peasants batted a shuttlecock to each other.	1898	First open tournament held at Guildford.
17th Century	'Battledore' – a game for the leisured classes.	1899	First All England Championships held at the London-Scottish drill hall at Buckingham Gate in London. Since 1949, they have been played at the Empire Pool, Wembley.
19th Century	'Shuttlecock and Battledore' was played in many English country houses.	1900	From this date onwards the game developed in Britain, Europe, the USA and Asia.
1850s	At Badminton House, home of the Duke of Beaufort, badminton was a popular game, being played in the front hall.	1901	The standard court of today was adopted.
1870s	Army officers on leave from India, staying at Badminton House, stretched a cord across a large room at shoulder height and started to play what is now known as badminton. Although the base lines were the width of the room, it had two large doors opening inwards on the side walls, and in order to allow people to enter and leave the room without disturbing the game in progress, the court was narrowed considerably at the net, making the original court "hourglass" shaped. It was usual to play 3 or 4 a side, singles being unknown.	1934	The International Badminton Federation (IBF) was formed.
1873	First set of rules of the game were devised in Poona, where the game was played outdoors.	1949	The first Thomas Cup competition was held, a men's international team competition for a trophy presented by Sir George Thomas.
1875	An officers' badminton club was formed at Folkestone; from then on clubs were formed in Southern England and the London area.	1956/57	The first Uber Cup competition was held, a ladies' international team competition for a trophy presented by Mrs Betty Uber.
1877	Rules were formulated by Lieutenant H.O. Selby in Karachi. They were revised in 1887, 1890 and 1893.	1977	First world championships held in Malmo, Sweden.
1893	The Badminton Association of England was founded in Southsea at a meeting of the representatives of fourteen badminton clubs. A uniform set of laws of the game was agreed at this meeting.	1979	Open badminton – the first open professional tournament, the Friends Provident Masters, was held at the Albert Hall, London in September.
		1980	After nearly half a century based at an office in Bromley, Kent, the Badminton Association of England moved to its headquarters at Milton Keynes. The National Badminton Centre has 8,500 square feet of building set in over 1¼ acres of land. The land around the headquarters has been developed as a national training centre with purpose-built badminton facilities and a hostel.
		1992	Olympic badminton. Badminton was seen as an Olympic sport for the first time at the Barcelona Olympics.





THE STRUCTURE OF THE SPORT (WORLDWIDE) The game of badminton is organised on both an international and a national basis, and Figures 9.1 and 9.2 illustrate the organisational structures.

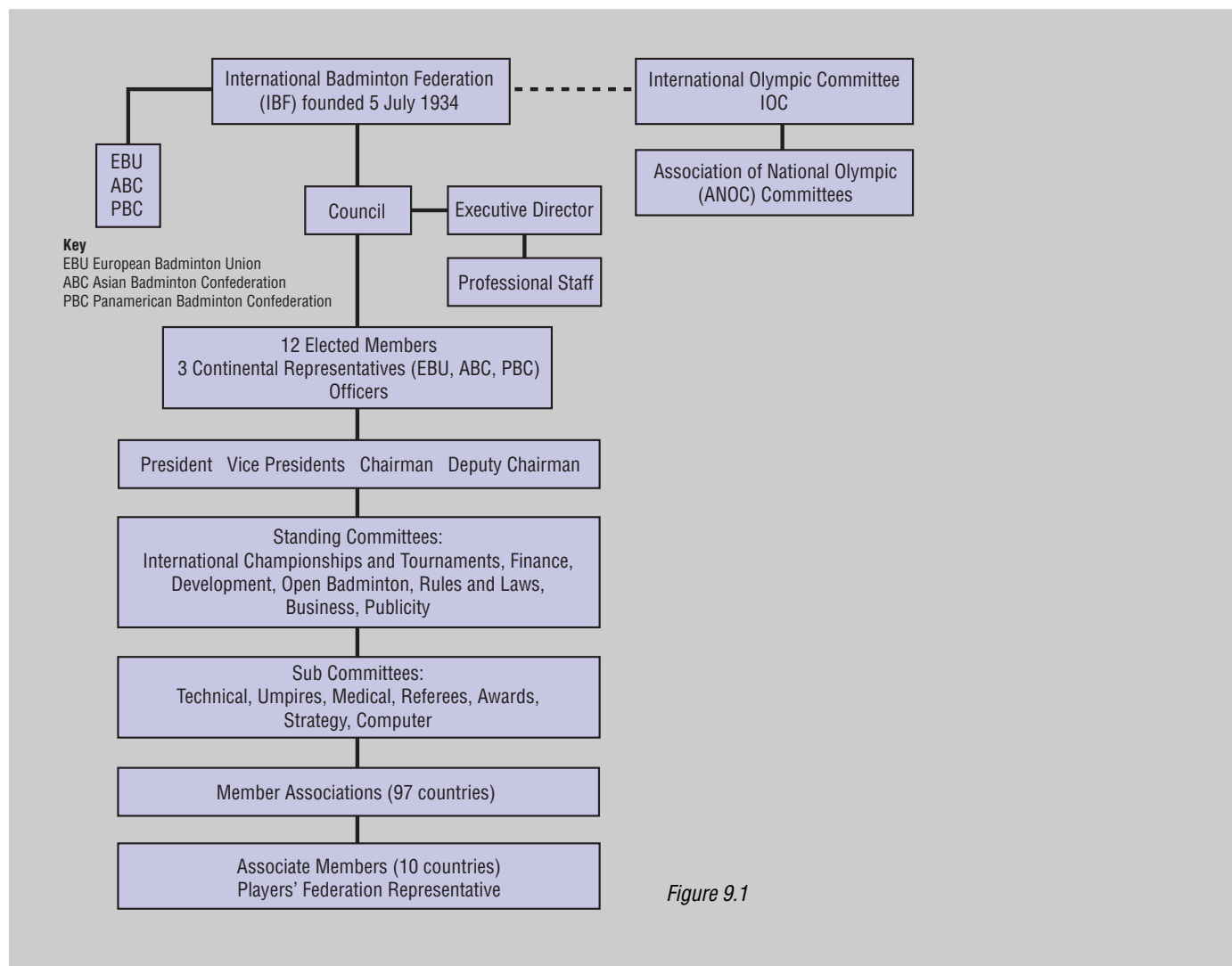

Figure 9.1

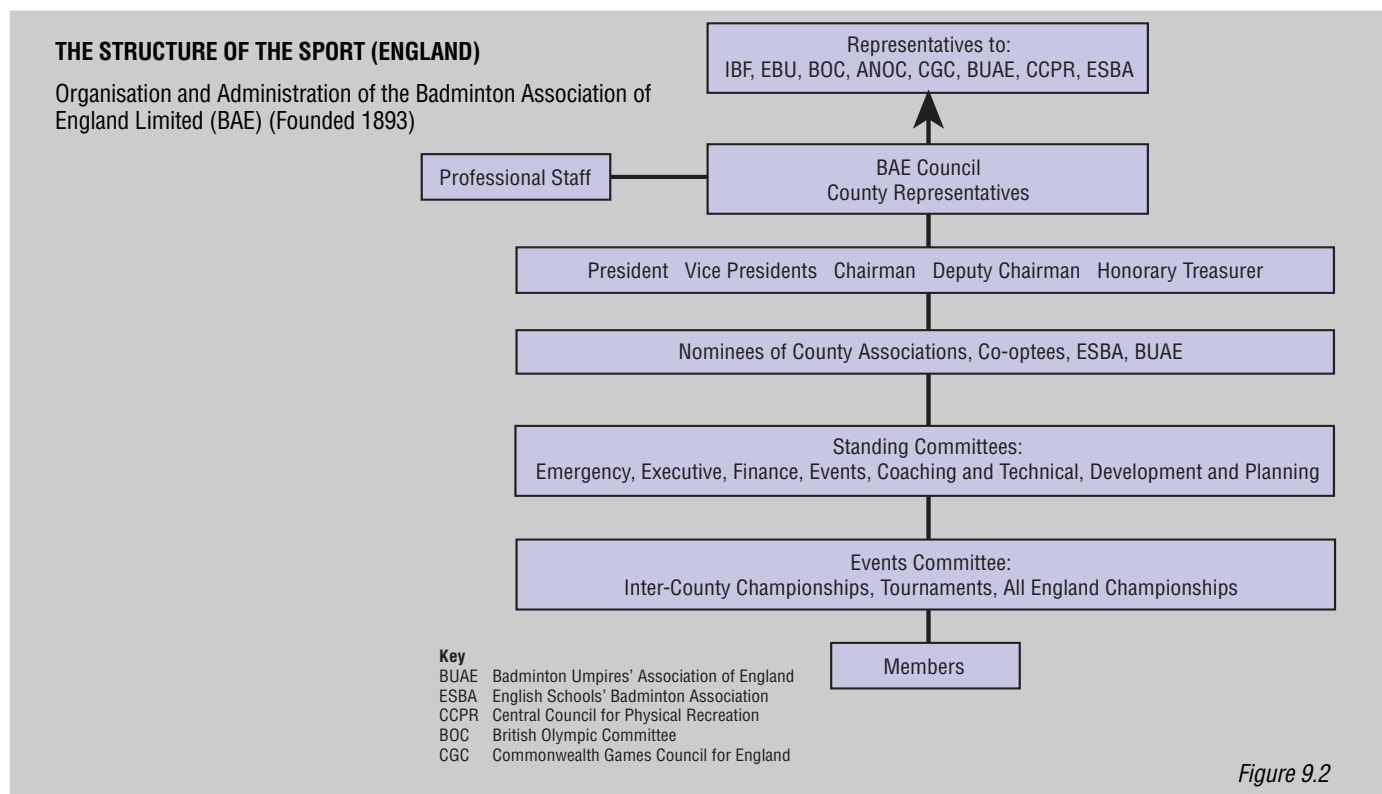

Figure 9.2



UNIT 10 Current Issues

DRUG ABUSE

The situation:

Drug taking to enhance performance is condemned in sport by governments, the International Olympic Committee, the International Badminton Federation, the Sports Council and the Badminton Association of England.

The reasons:

Performance-enhancing drugs are banned in sport because they can harm health and cause death, and because they give an unfair advantage to athletes, i.e. using drugs is cheating.

Who is affected?

All competition badminton players, regardless of age, will be liable for testing at competitive and squad training events.

Who is responsible?

Each player has the responsibility to make sure that they are not taking any drug which is on the banned list. The presence of a drug in the urine constitutes an offence, irrespective of how it got there.

If players are ill or injured it may be necessary for them to take prescribed drugs which are not banned to ease pain and / or aid recovery and players should make sure that their doctor prescribes one of these.

For up-to-date information regarding banned drugs and treatment guidelines contact:

UK Sports Council,
Ethics and Anti-Doping Control Unit
Walkden House
10 Milton Street
London
NW1 2EB
Telephone: 020 7380 8030

REMEMBER: YOU ARE RESPONSIBLE

Other Information

Players should be aware that excessive amounts of caffeine can cause a competitor to break the IOC doping rules. Coffee, instant coffee, tea and original coca cola contain varying amounts of caffeine, and the advice from the British Olympic Association is to avoid drinking any beverage unknown to you, unless you are certain that it does not contain any substance which could cause you to break the IOC doping rules. No competitor should drink more than three cups of tea or coffee prior to an event.

BADMINTON FOR DISABLED PEOPLE

Society as a whole is becoming more aware of the need for people with physical or mental disabilities to have the same opportunities as other people to participate and achieve in sport with dignity. There are seven disability organisations working to this end. Advice ranges from counselling for sport suitability to training and competitive opportunities.

Disabled badminton players may participate socially, but for those who wish to compete, the laws have been amended according to the category of disability.

Ambulant: People requiring no mechanical aid to perambulate. No change in the laws. For example deaf players, for whom National, European and World championships are held.

Semi-ambulant: People capable of erect perambulation, but only with mechanical aid, e.g. crutch(es), stick(s), support frame, leg brace(s), artificial leg(s).

Non-ambulant: People whose disabilities dictate that they adopt a sedentary position using support, e.g. chair, wheelchair, stool.

Amendments are made to court dimensions and to certain laws.

THE MEDIA

Badminton became increasingly popular in the 1960s with the availability of multi-court sports halls, but the media in England has failed to recognize the public interest. Newspapers give little coverage, and television interest is intermittent. Other sports such as soccer, boxing, athletics and golf attract big television audiences and have an abundance of star names.

Major television companies lack air time for 'minor sports', and other companies may have air time, but not the money. The possibility of badminton's financing its own television coverage is remote, as this means finding sufficient money to fund the broadcasts, and to place the programme on one of the channels. There is ongoing investigation into the presentation of the sport, including camera angles, scoring format and match presentation.

The scene is different in some other countries; for example in Indonesia and Malaysia, where badminton dominates media coverage. In the 1992 and 1996 Olympic Games, Indonesia, Malaysia, Korea and China dominated the badminton medals table, ensuring increased interest and sponsorship in those countries.





UNIT 11 Award Schemes

BAE COACHING AWARDS

AWARD	DURATION (HOURS)	ASSESSMENT	AGE	NOTES
Short Badminton Leader's Award	9	Ongoing	Over 18	
Leader's Award (disabilities)	12	Ongoing	Over 18	
Badminton Leader's	9	Ongoing	Over 16	
Teacher's Award	12	Ongoing	Over 18	For teachers and students in teacher training education
Instructor Award	28	Examination	Over 18	
Coach Award Part 1	25	Ongoing, including player study and examination	Over 18	Final assessment after 8 weeks coaching practice
Coach Award Part 2	32	Ongoing, including player study and examination	Over 18	Includes BAE practical modules + optional NCF theory modules
NVQ	The training and accreditation of coaches will undergo changes throughout the introduction of National Vocational Qualifications. This could have an effect on career pathways, differential rates of pay, mobility (within Europe) and greater public recognition of the coach's role. Implementation will be by National Governing Bodies in conjunction with the National Coaching Foundation.			

BADMINTON PLAYER AWARDS

(Run by English School's Badminton Association)

Key Stage 2 Pack

The Awards are aimed at Key Stage 2 pupils i.e. 7 to 11 year olds and would normally be used within schools. They incorporate National Curriculum tasks.

The pack contains workcards describing the tasks that have to be completed to obtain each of the three Awards, Gold, Silver, Bronze.

Also in the pack are Teacher Information sheets with suggestions on how groups could be organised to enable the tasks to be completed. There are record sheets for both individuals and classes, as well as workcards describing group activities which could help enhance the skills needed to play racket sports and badminton in particular.

Key Stage 3/4 Pack

These Awards are intended for use both within schools and in other coaching situations. The First and Intermediate Awards are for people of all ages who have only just started to play badminton and can therefore be used by both Teachers and Coaches.

The three Awards, Gold, Silver and Bronze are practically based Awards aimed mainly at Key Stages 3 and 4 in schools, i.e. eleven to

sixteen year olds but can easily be adapted to coaching groups. The Supreme Award is for students who achieve a Key Stage 4 Gold Award and also satisfactorily complete 2 written Badminton related topics.

Students with special needs may be assessed accordingly.

The pack contains full details of each Award and workcards for each of the individual skills of badminton, with notes for the Teachers and Coaches on possible ways of introducing them into a lesson. National Curriculum levels are suggested.

Also in the pack are record sheets, safety hints, ESBA's Code of Conduct, notes on how to organise various forms of competition, warm up/cool down etc.

For all the Awards, certificates and badges can be purchased from ESBA.

ESBA

For up to date details of what's happening in the world of junior badminton join ESBA. Details may be obtained from the ESBA secretary, National Badminton Centre, Bradwell Road, Loughton Lodge, Milton Keynes, MK8 9LA. Phone 01908 268400 Fax 01908 268412.

Website: <http://homepages.nildram.co.uk/~esba>

E-mail: info@badeng.powernet.co.uk





UNIT 12 Code of Conduct

Participation in badminton should give young people the opportunity to co-operate and compete in a rewarding physical activity.

The Badminton Association of England, the English Schools Badminton Association and the National Coaching Foundation have suggested guidelines covering different circumstances but with the common aim of providing a safe and healthy environment in which the individual can develop both as a player and as a person.

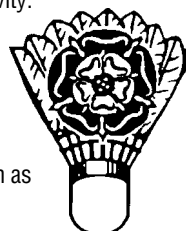

The Ten Commandments (ESBA)

1. In attitude be serious, competitive, pleasant and well mannered.
2. There will always be stronger and weaker players than yourself. Treat them with equal respect and courtesy.
3. Win or lose graciously, accepting your victory or defeat with dignity. Bad temper and melodrama have no place in our sport.
4. Irritating time-wasting, off-putting tactics are totally unacceptable.
5. Bad line calls and fault serving create ill feeling very quickly. Make sure that YOU are always scrupulously fair.
6. Make sure you understand the Laws. A few are obscure, but most are straightforward.
7. Should you be faulted by an Umpire or Service Judge and you genuinely do not know why – ask politely. Then acknowledge the answer. At the end of a match, as well as thanking your opponent, always thank both the Umpire and Service Judge. Should you also have linesmen, a cheery wave of thanks is a pleasant gesture.
8. In a game without an Umpire, should you feel that you are being cheated by your opponent DO NOT GET ANGRY. Quietly report to the Referee and explain the situation.
9. Always remember that many eyes and ears are watching and listening. Your reputation is in your own hands, but never forget that you are an advertisement not only for yourself, but for your parents, teachers and coaches.
10. One further essential – ENJOY YOUR SPORT!

In conclusion:

In order to make it possible for you to play:

Many officials have given freely of their time and experience to organise events.

Your teachers and coaches do likewise to help you.

Most parents make financial sacrifices to enable you to travel and compete.

An appreciation of these facts, an attitude of co-operation, and a simple “thank you” to all the above, are the signs of a pleasant, mature competitor.





USEFUL ADDRESSES

Badminton Association of England Ltd
National Badminton Centre
Bradwell Road
Loughton Lodge
Milton Keynes MK8 9LA
Telephone : 01908 268400

English Schools Badminton Association – as above

International Badminton Federation
Manor Park Place
Rutherford Way
Cheltenham
Gloucestershire GL51 9TU
Telephone : 01242 234904 (24 hour) 517157 (day)

The National Coaching Foundation
114 Cardigan Road
Headingley
Leeds LS6 3BJ
Telephone : 0113 274 4802

Scottish Badminton Union
Cockburn Centre
40 Bogmoor Place
Glasgow
Scotland G51 4TQ
Telephone: 0141 44 51218

RECOMMENDED READING

Badminton Association of England Ltd Annual Handbook – Badminton Association of England Ltd (BAE)

Laws of Badminton – *BAE*

Instructor's Manual (for coaches) – *BAE*

Fair Play for Children in Sport – *NCF/BAE*

Take Up Badminton – *Barbara Jones, 1989, Springfield Books Limited*

Badminton in a Week – *Barbara Jones, 1992, Headway – Hodder and Stoughton*

Winning Badminton Singles – *Jake Downey, EP 1982*

Winning Badminton Doubles – *Jake Downey, A&C Black 1984*

Play Short Badminton (Handbook) – *NCF 1993*

Badminton History – *Bernard Adams, B.B.C. 1989*

Safety Guidelines – *BAE, May 1992*

Code of Ethics and Code of Conduct – *BAE*

Get Fit for Badminton – *Downey, J & Brodie, D, Pelham Books 1980*

Sporting Body, Sporting Mind – *Connolly. C & Syer. J, CUP 1987*

VIDEOS:

IBF Coaching Videos *Basic Footwork*

Basic Strokes

IBF & BAE Videos *Match Play*

